

Digital Entertainer Elite EVA9000/9150 User Manual



NETGEAR®

NETGEAR, Inc.
350 E. Plumeria Drive
San Jose, CA 95134 USA

202-10516-01
March 2009

© 2009 by NETGEAR, Inc. All rights reserved.

Trademarks

NETGEAR, the NETGEAR logo and the NETGEAR Digital Entertainer logo are registered trademarks of NETGEAR, Inc., in the United States and/or other countries. Other brand names mentioned here are for identification purposes only and may be trademarks of their respective holder(s).

Dolby Digital

Dolby and the double-D symbol are trademarks of Dolby Laboratories. Manufactured under license from Dolby Laboratories. Confidential unpublished works. Copyright 1992-1997 Dolby Laboratories. All rights reserved.

Statement of Conditions

In the interest of improving internal design, operational function, and/or reliability, NETGEAR reserves the right to make changes to the products described in this document without notice. NETGEAR does not assume any liability that may occur due to the use or application of the product(s) or circuit layout(s) described herein.

Customer Support

Refer to the Support Information card that shipped with your Digital Entertainer Elite, EVA9000/9150.

World Wide Web

NETGEAR maintains a World Wide Web home page that you can access at:
<http://www.netgear.com>.

A direct connection to the Internet and a Web browser such as Internet Explorer or Netscape are required.

Product and Publication Details

Model Number: Models EVA9000 and EVA9150
Publication Date: March 2009
Product Family: Digital Media Player
Product Name: Digital Entertainer Elite, EVA9000/9150
Home or Business Product: Home
Language: English
Publication Part Number: 201-10516-01
Publication Version Number: 1.0

Contents

Digital Entertainer Elite EVA9000/9150 User Manual

About This Manual

Conventions, Formats, and Scope	vii
Version History	viii

Chapter 1

Welcome to the Digital Entertainer Elite

Important Safeguards and Notices	1-1
What Is in the Box	1-1
Overview of the Digital Entertainer Elite	1-2
Digital Entertainer Elite Front View	1-4
Digital Entertainer Elite Rear View	1-5
NETGEAR Universal Remote Control	1-6

Chapter 2

Basic Setup

Connecting the Digital Entertainer Elite	2-1
Completing the Basic Setup Steps	2-3
Enabling Access to Your Media Library	2-5
Installing the Digital Entertainer for Windows Software	2-5
Giving the Digital Entertainer Elite Access to Your Media Library	2-6

Chapter 3

Getting Acquainted

Navigating with the Remote Control or from a Computer	3-1
Navigating with the Remote Control	3-1
Navigating from a Web Browser	3-3
Using Protected Media Files	3-6
Using Windows Media Player 11	3-6
Using iTunes for Windows	3-7
Using Multiple Digital Entertainer Elites	3-7

Chapter 4

Listening and Viewing

Listening to Music	4-1
Using the Remote Control When Music Is Playing	4-2
Listening to Protected Music	4-3
Viewing Photos	4-4
Using the Remote Control While Viewing Photos	4-5
Viewing Recorded Video	4-6
Watching Recorded Video	4-6
Using the Remote Control When Recorded Video Is Playing	4-7
Using the USB Connection for Pictures, Music, or Video	4-8
Installing and Using an Internal Disk Drive for Pictures, Music, or Video	4-9
Installing an Internal Disk Drive	4-9
Setting Up the Internal Disk Drive	4-12
Drag and Drop Media Files to the Internal Disk Drive	4-12
Playing Internet Media	4-13
Viewing YouTube Content	4-14
Using the Remote Control When Viewing YouTube Content	4-15
Playing Internet Radio	4-16
Using the Remote Control When Playing Internet Radio	4-17
Viewing News and Weather	4-17
Combining Different Media Sources	4-18
Viewing the Status of Multiple Digital Entertainer Elites	4-18
Viewing Status	4-19

Chapter 5

Fine-Tuning Your Experience

Improving Media Library Search Results	5-1
Using the Tag Tool Application	5-1
Adding Cover Art	5-2
Using the Script Wizard to Automate Tasks	5-4
Understanding Home Networking	5-5
Assessing Your Speed Requirements	5-7
Optimizing the Performance of Your Home Network	5-7
Optimizing Wireless Performance	5-7
Optimizing Your Network Bandwidth	5-9

Optimizing Media File Performance	5-10
Tips for Streaming Video	5-11
Taking Precautions	5-11
Access and Network Security	5-11
Exercising Parental Control	5-12

Chapter 6 Custom Setup and Supervisor Functions

Custom Setup	6-1
Supervisor Functions Menu Screen	6-2
Hard Drive Tools	6-3
Advanced Settings	6-3
Power and Hard Drive Tools	6-5
Setting Up Network Shares	6-7
Media Library Management	6-7
More... Settings	6-8
System Information	6-9
Setting Up Hot Keys	6-9
Using PC Access	6-9

Chapter 7

Maintenance and Troubleshooting

Resetting to Factory Defaults	7-1
Updating the Firmware	7-1
Playing Media	7-2
Firewall Port Settings	7-2
Accessing Your Digital Media	7-3
Windows System Passwords	7-3
Macintosh OSX	7-3
Linux	7-3
Error Messages	7-4
Troubleshooting Tips	7-6
Network Connections	7-7
Ethernet LAN Connection	7-7
Troubleshooting a Wireless Network Connection	7-7
Wireless Range and Interference	7-8
Wireless Networking Tips	7-8

IP Address	7-9
Connecting to a Server	7-9
Unlocking the Disk Drive Tray	7-11

Appendix A

Default Configuration and Technical Specifications

Default Settings	A-1
Supported Media File Formats	A-2
Technical Specifications	A-2

Appendix B

Related Documents

Index

Compliance

About This Manual

The *NETGEAR® Digital Entertainer Elite EVA9000/9150 User Manual* describes how to install, configure and troubleshoot the Digital Entertainer Elite for the models EVA9000 and EVA9150. The information in this manual is intended for readers with intermediate computer and Internet skills.

Conventions, Formats, and Scope

The conventions, formats, and scope of this manual are described in the following paragraphs:

- **Typographical Conventions.** This manual uses the following typographical conventions:

<i>Italic</i>	Emphasis, books, CDs, file and server names, extensions
Bold	User input, IP addresses, GUI screen text
<i>italic</i>	URL links

- **Formats.** This manual uses the following formats to highlight special messages:

	Note: This format is used to highlight information of importance or special interest.
---	--

	Tip: This format is used to highlight a procedure that will save time or resources.
---	--

	Warning: Ignoring this type of note may result in a malfunction or damage to the equipment.
---	--



Danger: This is a safety warning. Failure to take heed of this notice may result in personal injury or death.

- **Scope.** This manual is written for the Digital Entertainer Elite according to these specifications:

Product Version	Digital Entertainer Elite, EVA9000/9150
Manual Publication Date	March 2009

For more information about network, Internet, firewall, and VPN technologies, see the links to the NETGEAR website in [Appendix B, “Related Documents.”](#)



Note: Product updates are available on the NETGEAR, Inc. website at <http://kbserver.netgear.com/products/EVA9000.asp>.

Version History

Table 1-1. Digital Entertainer Elite EVA9000/9150 User Manual Version History

Version	Publication Date	Description
1.0	March 2009	Original document

Chapter 1

Welcome to the Digital Entertainer Elite

Important Safeguards and Notices

Please observe these precautions, especially those regarding the risk of electric shock or injury to persons.



Danger: To reduce the risk of electric shock, do not remove the cover. There are no user-serviceable parts inside. This device should be used only indoors in well-ventilated areas. To reduce the risk of fire, electric shock, or interference, do not expose this appliance to moisture or rain, and use only the recommended accessories.



Warning: Displaying static images can cause burn-in on certain displays. Do not display static images (such as menus, photos, or paused videos) onscreen for long periods of time.

What Is in the Box

The Digital Entertainer Elite comes with the following components:

- Digital Entertainer Elite (Model EVA9000 or EVA9150)
- NETGEAR Universal Remote Control
- Category 5 (Cat 5) network cable
- Composite RCA-type A/V cable
- HDMI cable
- IEC power cable
- Two AA batteries
- *NETGEAR Resource CD* for use with Windows-based PCs and Macintosh computers
- *Installation Guide*

Contact your dealer to get a replacement for any missing component.

Overview of the Digital Entertainer Elite

You can play media on the Digital Entertainer Elite without running media server software on your computer. The Digital Entertainer Elite can work with Windows, Macintosh, and Linux operating systems and various handheld computers. You can work with a wide variety of digital storage formats and systems. The Digital Entertainer Elite enables you to view them as a single media library that you can browse through on your television screen.

- **NETGEAR Digital Entertainer for Windows software**

This software provides a variety of media management tools that make it easy to access media files stored on a Windows PC. You can perform many of the same tasks on non-Windows computers using the native utilities of those systems. The NETGEAR Digital Entertainer for Windows includes the following applications:

- **Configuration Wizard.** This application helps configure PCs to share media, automatically set firewall settings, and verify communications between PCs and the Digital Entertainer Elite.
- **Check for Updates.** This application uses your Internet connection to check for software updates. If an update is available, you can choose to download and install it.
- **Digital Entertainer.** This application lets you access your Digital Entertainer Elite from your PC. This software is required for some functions on the Digital Entertainer Elite: Access PC, YouTube video playback, and playback of protected iTunes media. You can also use the application to monitor status of your Digital Entertainer Elite, and to start media playback on it.
- **Documentation.** Use the *NETGEAR Resource CD* to view the *Installation Guide*, the *Universal Remote User Manual*, or the software Readme file.
- **Tag Tool.** This application applies tags and cover art to media files to make using your media library easier. Also used to add an MPAA or TV rating to video files for parental control restrictions.
- **Script Wizard.** This application lets you automate tasks. You can create virtual playlists to play any combination of media. You could create a playlist or command to play a sequence of videos, or to view photos while playing music.

- **NETGEAR Digital Entertainer for Macintosh software**

This software provides a variety of media management tools that make it easy to access media files stored on a Macintosh computer.

- **Configuration Assistant.** This application helps configure Macintosh computers to share media, automatically set firewall settings, and verify communications between your computer and the Digital Entertainer Elite.
 - **Status Check.** This application displays the status of your NETGEAR Digital Entertainer Elite. (Not yet available.)
 - **Remote Control.** This application allows you to control your NETGEAR Digital Entertainer Elite from your computer.
 - **Tag Tool.** This application applies tags and cover art to media files to make using your media library easier. Also used to add an MPAA or TV rating to video files for parental control restrictions
 - **NETGEAR documentation.** This is a link to the website where you can download the latest versions of the *Installation Guide*, the *Universal Remote User Manual*, and this *User Manual*.
 - **Updater.** This application checks for updates to the Digital Entertainer Elite software.
- **Multi room playback**

Digital Entertainer Elites within the same home can intelligently share resources. You can have all the Digital Entertainer Elites and Digital Entertainer HDs play the same music simultaneously.
 - **Parental controls and monitoring**

The Digital Entertainer Elite can block access to media files based on a rating you assign to the files or based on their location in your network. You can also limit access to Internet media.
 - **Pre-installed hard disk drive**

The EVA9150 comes with a pre-installed hard disk drive; the EVA9000 does not. You can install a different hard disk drive on either model. For more information, see [“Installing and Using an Internal Disk Drive for Pictures, Music, or Video”](#) on page 4-9.

Digital Entertainer Elite Front View

The front view of the of the Digital Entertainer Elite is shown in the following figure:

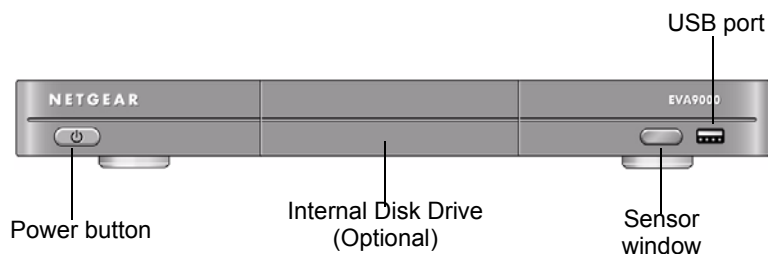

Figure 1-1

A pre-installed hard disk comes with the EVA9150. For the EVA9150, you can install a different hard disk than the one that comes pre-installed, if you prefer. For the EVA9000, you can install a hard disk into the disk tray. Any hard disk that you install should be a 3.5" SATA-II with SMART support. NETGEAR recommends a drive of at least 40GB and up to 1TB.

- For a list of supported drives, see www.netgear.com/eva9000drive.
- For instructions about how to install an optional hard disk, see the *Digital Entertainer Elite EVA9000/9150 Installation Guide* or “[Installing and Using an Internal Disk Drive for Pictures, Music, or Video](#)” on page 4-9 of this manual.

Digital Entertainer Elite Rear View

The rear view of the Digital Entertainer Elite is shown in the following figure:

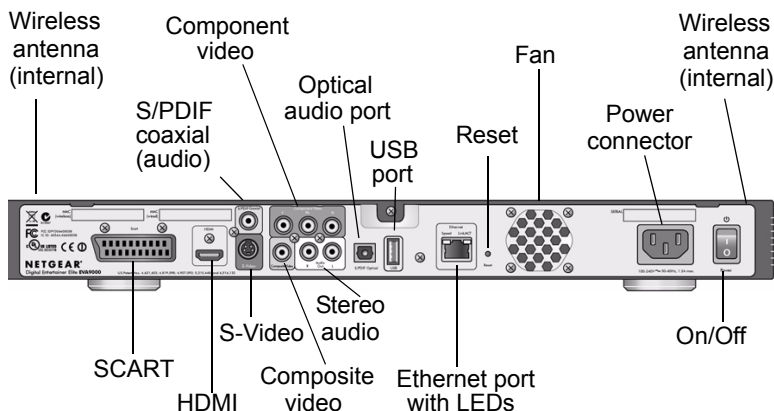

Figure 1-2

The Digital Entertainer Elite is compatible with all cables described in the following table, though some cables are not included in the package.

Table 1-1. Rear Panel Description

Item	Compatible Equipment and Cables
SCART port	SCART television cable (not included) that is widely used in Europe and Australia.
HDMI port	High-Definition Multimedia Interface (HDMI) cable (not included). If your television has an HDMI connector, you can use this cable for both the audio and video signal.
S/PDIF coaxial (audio) port	Sony/Phillips Digital Interface (S/PDIF) cable, also called standard RCA type coaxial cable (not included).
S-Video port	S-Video cable (included) that works with most televisions in the United States.
Component video ports	Component video cable (not included).
Composite video and stereo audio port	Composite video and stereo audio cables (included), which can be used with most televisions in the United States.
S/PDIF optical audio port	Sony/Phillips Digital Interface (S/PDIF) for optical cable (not included).

Table 1-1. Rear Panel Description (continued)

Item	Compatible Equipment and Cables
USB v2.0 port	USB mass storage devices such as hard drives, media players (including Windows- or Mac-formatted Apple iPods), and flash memory devices.
10/100 Mbps Ethernet port with LEDs	Cat 5 network cable (included in the package) that you can use with this port to connect the Digital Entertainer Elite to a wired local area network (LAN).
Reset button	Reset the Digital Entertainer Elite to its default factory settings. To reset, press and hold the button down while the unit is powering up. The Power LED blinks to acknowledge the reset request.
Fan	Fan for cooling the optional internal hard drive. The fan operates only when a hard drive is installed.
Power connector	IEC Digital Entertainer Elite power cord (included).
On/Off switch	Turns the Digital Entertainer Elite on or off.
Wireless antennas (internal)	The internal wireless antennas support IEEE 802.11n, IEEE 802.11g, and IEEE 802.11b. Keep the internal wireless antennas clear of metallic obstructions.

The only inputs on the Digital Entertainer Elite are the USB ports and the Ethernet port.

NETGEAR Universal Remote Control

Use the NETGEAR Universal Remote to operate the Digital Entertainer Elite and up to three additional home entertainment devices. This guide describes how to use the remote with your Digital Entertainer Elite, EVA9000/9150. For information about programming your remote to control other devices, see the *Universal Remote User Manual*.



Tip: If the Digital Entertainer Elite does not respond when you are using your remote, press the  **DE** button on the device and try again.

Table 1-2. Remote Control Buttons



































Button	Description
	Power. Turn the device on and off.
	Back. Go back to the previous screen.
	Navigation. Navigate the menu selections.
	Home. Display the main menu.
	DE. Set the device mode to control the Digital Entertainer Elite.
	TV. Set the device mode to control another home entertainment device, such as a TV, that has been programmed on the remote.
	DVD. Set the device mode to control another home entertainment device, such as a DVD player, that has been programmed on the remote.
	AUX. Set the device mode to control another home entertainment device, such as cable or satellite receivers, amplifiers, tuners, or other auxiliary devices, that has been programmed on the remote.
	Eject. Restarts DVD (IFO/ISO) playback from the beginning of the disk.
	Play. Play or resume playing the media. This button also resumes normal play from fast wind mode. In the media menus, Play plays the selected item and queues up the rest of the items in the order shown on the screen.
	Pause. Pause the media.
	Stop. Stop the media that is currently playing.
	Not used.
	Rewind. Rewind to the beginning of the media that is playing.
	Previous. Skip back to previous item playing. When you are navigating the menus, this button takes you directly to the first item in the list.
	Fast-forward. Fast-forward the media that is playing.
	Next. Skip forward to next item on the playlist. When you are navigating the menus, this button takes you directly to the last item in the list.
	Select and Play. Press OK to select a menu item or to play a single song or video.

Table 1-2. Remote Control Buttons (continued)

Button	Description
	Information. Display media information.
	Volume. Increase or decrease volume.
	Page up and Page down. This button is also used for the following: <ul style="list-style-type: none"> • Scroll up or down. • Zoom videos and photos. • Change channels when the remote is programmed for another device, such as a TV (see the <i>Universal Remote User Manual</i> for more information).
	Mute. Mute or unmute the sound.
	Music. Display the Music menu. If you are currently navigating music, the Music button jumps directly to top level music menu.
	Video. Display the Video menu. If you are currently navigating video, the Video button jumps directly to top level video menu.
	Pics. Display the Picture menu. If you are currently navigating pics, the Pics button jumps directly to top level pics menu.
	Web. Display the Internet media menu.
	Menu. Toggles to and from full screen mode during video or photo playback. During video playback, press Menu to display the DVD main menu or the audio and subtitle options.
	Caps. Toggle Caps Lock or numbers on or off.
	TV Mode. Cycle between TV output modes.
	Repeat. Repeat a track or media selection.
	Zoom. Change the aspect ratio of videos or photos.
	Enter. Enters or selects a setting or option.
	Rotate. Rotate a photo.
	Set. Enters settings when you are configuring the NETGEAR Universal Remote.
0-9	Use for alpha-numeric entry, choosing presets, and searching.
A-D	Use to assign macros that can perform multi-step operations by pressing a single button.
CLR	Clear. Clears all text from a text entry field (for example, a YouTube search box).

For information about using buttons with specific media, see [Chapter 3, “Getting Acquainted.”](#)

Chapter 2

Basic Setup

In the order listed, complete these three steps to set up your Digital Entertainer Elite:

1. Connect the Digital Entertainer Elite.
2. Connect to your network using the Digital Entertainer Elite Basic Setup option.
3. Use the NETGEAR Digital Entertainer for Windows software to enable the Digital Entertainer Elite to access your media library.

For custom installations, such as using more than one Digital Entertainer Elite or working with Macintosh or Linux computers, see [“Advanced Settings” on page 6-3](#).

Connecting the Digital Entertainer Elite

To connect the Digital Entertainer Elite:

1. Connect the Digital Entertainer Elite according to the options available in your entertainment system.

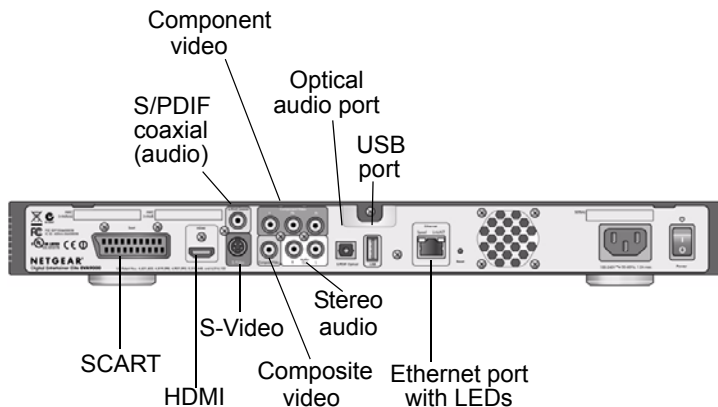

Figure 2-1

For example, connect the composite video cables between your entertainment system and the Digital Entertainer Elite.

If you use a digital audio/visual (A/V) receiver, NETGEAR recommends that you use an S/PDIF coaxial or an optical cable to connect it.

The quality of the picture display is related to the video format you use. If your television supports multiple formats, choose the format that provides the best picture quality. HDMI offers the best picture quality video. Component video provides the next best quality, followed by SCART, S-Video, and composite video.

2. Connect the Digital Entertainer Elite to your network.
 - If you are connecting to an Ethernet LAN, connect the Digital Entertainer Elite to the LAN with an Ethernet cable.
 - If you are connecting to your wireless network, configure the wireless settings of the Digital Entertainer Elite using the Basic Setup steps described in the following section. Be prepared to provide the wireless network name (also called SSID) and the wireless security settings for your network.
3. Turn on the television.



Note: Turn on the television before you turn on the Digital Entertainer Elite.

4. Set the video source selector on your television to match the connection from your Digital Entertainer Elite. For example, if you used an HDMI connector, set the television to use Digital HD or HDMI input.
5. Connect the power cord to your Digital Entertainer Elite, and plug it into an outlet.

The LED on the front of the Digital Entertainer Elite lights up to show that it is powered on.
6. Install the two AA batteries into the remote control that came with the product.
7. Optimize the television display as necessary.
 - If the display is not sharp, or you do not see a picture, aim the NETGEAR remote control at the Digital Entertainer Elite, and press the **TV Mode** button.
 - You can cycle through the TV modes to get the best display.



Note: It can take 5 to 10 seconds for each TV mode change. In some modes you might not see a picture on the TV. If you do not see a picture after four mode changes, check the cable connections, and verify that the TV is on and set to the correct input.

- You might be able to enhance the picture quality by selecting from additional high-definition video modes in the advanced settings.
8. When prompted, select a language, and press **OK**.
 9. When you hear the audio welcome tune, press **OK**.

If you do not hear the audio welcome message, check your volume settings and the connections to the Digital Entertainer Elite.

You will now use the Basic Setup option to finish setting up your Digital Entertainer Elite.

Completing the Basic Setup Steps

The Basic Setup option enables the Digital Entertainer Elite to use media files that are on Windows PCs or Macintosh computers. If you use Linux or have a complex home network, use the functions described in [“Custom Setup and Supervisor Functions” on page 6-1](#).

Follow these steps for the Basic Setup option:

1. After the audio welcome message, select **Basic Setup**, and then press **OK**.

The Digital Entertainer Elite checks for a network connection. If connected to an Ethernet network that is running DHCP (the usual case for home networks), the Digital Entertainer Elite automatically joins the network. Skip to [step 3](#), [“Connect to the Internet](#).

2. Connect wirelessly (optional). If an Ethernet LAN connection is not found, you can wirelessly connect your Digital Entertainer Elite to the network.

Select **Connect Wirelessly**, and then select one of the following options:

- **Connect using Push 'N' Connect**

If your router supports Wi-Fi Protected Setup (WPS) push button automatic configuration, you can add the network name (SSID) and security settings automatically using the Push 'N' Connect feature. Select your network from the list, select **OK**, and then push the WPS button on your router. Select **OK** to continue. See your router documentation for more information on WPS support.

- **Connect Manually**

The available networks are displayed in a list sorted alphabetically. You might have to scroll to see your network. Select your network from the list, or enter the required network name (SSID) and security settings as needed. Select the network that provides 5 Ghz connection for maximum bandwidth, if available.

Wait for the Digital Entertainer Elite to connect to the wireless network. If the connection is successful, information about the network settings is displayed. Press  **OK** to accept the settings.



Tip: If the Digital Entertainer Elite does not connect to your wireless network, the options screen is displayed. Check to make sure that the wireless settings for the Digital Entertainer Elite match the wireless network exactly, and then try again. See [“Troubleshooting Tips” on page 7-6](#). For more information about wireless networks and wireless security, see [“Preparing a Computer for Network Access” in Appendix B](#).

3. Connect to the Internet.

After the Digital Entertainer Elite connects to your network, it tries to connect to the Internet. A message confirms that the Internet connection is available.

- Depending on where you bought your Digital Entertainer Elite, you might be prompted to enter your zip code.

To receive local news and weather, enter your zip code, navigate to the **OK** button, and then press  **OK**.

- If the Digital Entertainer Elite does not connect to the Internet, use your computer to see if your Internet connection is working. The following options display on the Digital Entertainer Elite:
 - Set up network configuration. Lets you view and change network settings.
 - Skip and use stand alone. Lets you use the Digital Entertainer Elite without a network. You can play media if you connect a USB drive with media on it. You will not be able to use these features: Internet radio, YouTube Video, Flickr photos, or weather.
 - Try again. Test your network connection. For example, you can use this option to check a LAN connection. First, check your cables to make sure that they are securely attached, and that the network is up and running. Then select Try again.

Upon completion of the Basic Setup steps, you are prompted to install software. Go to the computer where your media files are located, and install the software from the *NETGEAR Resource CD*, according to the instructions in the following section.

Enabling Access to Your Media Library

For the Digital Entertainer Elite to access your media files, you must share the media folders on your computers. Although you can manually use the Windows Sharing and Security option to share media folders, it is much easier to use the Digital Entertainer for Windows software on the *NETGEAR Resource CD* to do so.

Installing the Digital Entertainer for Windows Software

Use the *NETGEAR Resource CD* to install the Digital Entertainer for Windows software on your Windows-based computer.



Note: The software on the CD is designed to make installation easier. Only the Digital Entertainer Control center is added to your startup configuration, and you can close this application at any time.

To install the Digital Entertainer for Windows software:

1. Power on your computer, and log in as necessary.
2. Insert the *NETGEAR Resource CD* into the CD drive on the computer.
3. The Welcome screen opens. If you do not see the Welcome screen, browse the files on your CD, and then click **Setup**.
4. Select Install the NETGEAR Digital Entertainer for Windows Software.



Figure 2-2

5. Follow the Setup Wizard steps to accept the license and install the software.
6. When the Setup Wizard finishes, click **Configure** to use the Configuration Wizard.



Figure 2-3

Giving the Digital Entertainer Elite Access to Your Media Library

Use the Configuration Wizard to share media files with the Digital Entertainer Elite. The Digital Entertainer Elite can access media files in more than one location at the same time. Use the Configuration Wizard to configure shared access to media files on the PC where you have them stored. The Digital Entertainer Elite performs a full scan of your network to combine the data into a media library.

To use the Configuration Wizard:

1. Click **Next** to begin. The Configuration Wizard displays.

The wizard prompts you to select media folders to be shared. This allows the Digital Entertainer Elite to access these files.



Figure 2-4

2. Browse and select the folders that you want to use, and then click **Next**.

The next screen displays when the wizard is ready to configure your Digital Entertainer Elite.

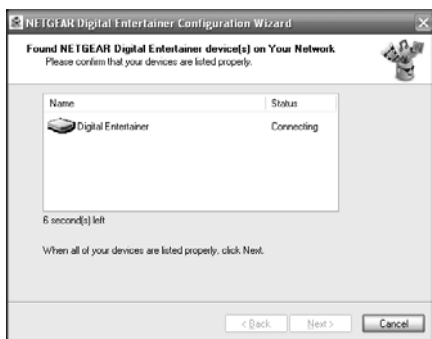

Figure 2-5



Note: If the wizard is unable to connect to your Digital Entertainer Elite, disable any third-party firewall or security software such as those from Symantec or McAfee. For more information, see [“Firewall Port Settings”](#) on page 7-2.

3. Select whether or not you want to create photo thumbnails, and then click **Next**.
4. When you see a message confirming that the configuration is done, go to your television.



Note: Depending on the media files you have, the initial full scan might take some time to complete.

You are finished with the installation and can play media on your Digital Entertainer Elite.

Chapter 3

Getting Acquainted

Now that the basic setup is complete, use the topics in this chapter to guide you through getting acquainted with your Digital Entertainer Elite.

Navigating with the Remote Control or from a Computer

The Digital Entertainer Elite lets you use either the remote control or a Web browser on a computer to navigate to your shared media files and select the ones that you want to play.

Navigating with the Remote Control

To go to the main menu, press  **Home** on the remote control.



Note: While you are viewing a slideshow or video, you can use the **Home** key to show and hide the main menu.



Note: If the Digital Entertainer Elite does not respond when using your remote, press the  **DE** button on the device and try again.

The main menu offers these selections:

- **Video.** Watch Internet or recorded video.
- **Music.** Listen to music files or Internet radio.
- **Photos.** View photos.
- **Internet Media.** Watch YouTube or Internet podcasts, view Flickr photos, browse Internet radio stations, or remove or add a station. See [“Playing Internet Media” on page 4-13](#).
- **News/Weather.** View news and weather. To receive local weather you must enter your zip code. You can enter your zip code during installation or through local settings. See [“Viewing News and Weather” on page 4-17](#).

- **PC Access.** Access your PC remotely to check e-mail or browse the web from your TV.







Tip: Do not use the PC Access feature to stream Internet video while browsing the Internet. This feature is intended for lower bandwidth tasks such as Web browsing and email.

- **More.** View or work with system functions. See [“Custom Setup and Supervisor Functions” on page 6-1.](#)”

Using the Remote Control

The following table describes how to use the remote control to navigate, depending on what task the Digital Entertainer Elite is performing. For a complete list of all remote control buttons, see [“NETGEAR Universal Remote Control” on page 1-6.](#)

Table 3-1. Using the Remote Control

Button	From the Main Menu	When Browsing Music, Videos, or Photos	In an Edit Field
	Go back to the previous screen.	Go back to the previous screen.	
	Move the selector up or down.	Move the selector up or down.	Go to the previous or next field. Left arrow erases 1 character. Right arrow goes to the next field or button on a screen.
	Select the highlighted item.	Select the highlighted item.	Edit the selected item.
	Hide menus if video or photos are playing.	Go to Home / main menu.	Cancel the edit and jump to the main menu.
	Move the selector one screen up or down.	Move the selector one screen up or down.	
0-9	If you set up hot keys, you can use them to play media. See “More... Settings” on page 6-8.	Find entries that contain the letters or numbers entered.	Enter characters into the edit field.

Tips When Using the Remote Control

Here are some tips to help you quickly locate media files.

- You can combine categories to narrow your search. For example, you can browse by genre and then by rating to get to R-rated action movies.
- Some audio or video files might be stored without information in some fields, such as album or genre. If this is the case, these tracks are listed in a category called Unknown. You can use the Tag Tool to fix these. See [“Using the Tag Tool Application” on page 5-1](#).
- You can enter letters contained in a title to quickly find a media file by name when browsing. For example, enter **EYE** to find both Goldeneye and For your Eyes Only.



Tip: To enter letters, tap the number button to get the letters that you want. For example, tap 6 twice to change from M to N.

Navigating from a Web Browser

You can access the Digital Entertainer Elite with any browser that supports HTML 3.2, including browsers on PCs and on most PDAs.



Note: Cookies must be enabled for the browser menus to work correctly.

From a browser, you can use the same menus displayed on the television. The browser interface works like the television menus in most instances. A few functions are available *only* through the browser interface. The browser interface makes it easy to set up your favorite Internet radio stations that are not on the Digital Entertainer’s top 500 list, to add RSS news feeds, and to configure complex network settings.

Using the Browser Interface

The browser interface screen is shown in the following figure:

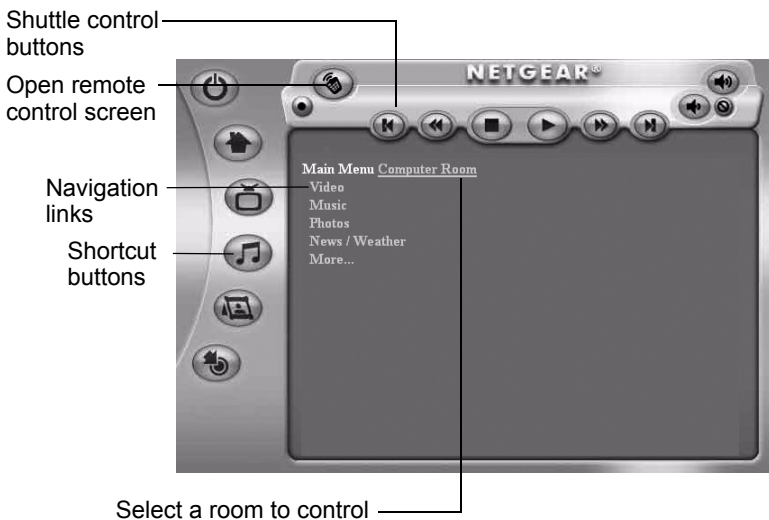

Figure 3-1

To access the browser interface, do one of the following:

- Right-click the Digital Entertainer for Windows task bar icon, and select the room name of the Digital Entertainer Elite that you want to access.
- Set your browser to the IP address of the Digital Entertainer Elite that you want to configure. To view the IP address, press **Home** and select More > Supervisor > System Information.

To change which room you are controlling, click the room name. A list of available rooms displays.

Playing Media from the Browser Interface

To start playing something, click a menu entry. For example, click Music to browse to the music you want to play, and then select a song. When media playback starts, the browser opens the remote control screen shown in the following figure.



Figure 3-2



Note: You can also click the Remote Control icon in the PC Browser Interface to open the remote control screen.

The buttons on this screen correspond to the Digital Entertainer Elite remote control. Click them to send commands to the Digital Entertainer Elite. For example, click **Volume Up** to increase the volume in the selected room.



Note: See [“Supported Media File Formats”](#) on page A-2 for a Web address for the list of supported formats.

Using Protected Media Files

You can play most media files that are protected by Digital Rights Management (DRM) on a Digital Entertainer Elite by selecting the Enable UPnP Media Sharing in the Configuration Wizard.

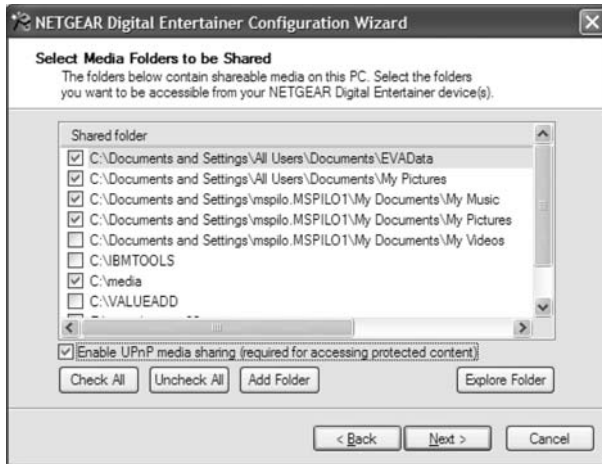

Figure 3-3

Alternatively, you can use:

- Windows Media Player Version 11
- iTunes for Windows

Using Windows Media Player 11

Media files bought or downloaded from online services such as Napster, MSN Music, MovieLink, and others are usually protected by Windows Media Digital Rights Management (DRM). They can be played only from a PC using Windows Media Player Media Sharing. Other third-party media servers do not work with these files.

The Configuration Wizard makes setting up Windows Media Sharing easy. Once you've installed Windows Media Player 11, use the Configuration Wizard to share your protected media with the Digital Entertainer Elite. Windows Media Player Version 11 can be downloaded from <http://www.microsoft.com/windows/windowsmedia/player/11/default.aspx>.



Note: If you use Windows Player Media Sharing to access downloads with DRM, NETGEAR recommends that you place all your protected media files in one folder, and use Windows Media Sharing to share only that folder. Then use the Configuration Wizard to share all other folders. See “[Connecting to a Server](#)” on [page 7-9](#).

Using iTunes for Windows

You can play protected iTunes audio files by running the Digital Entertainer for Windows software on the PC on which iTunes is installed. You cannot play protected iTunes directly from a Mac. You must authorize a PC and install iTunes on the PC so that it plays songs. See “[Listening to Protected Music Stored on a Mac](#)” on [page 4-4](#) for more information.

Using Multiple Digital Entertainer Elites

You can have multiple Digital Entertainer Elites on your home network. Features available for this type of installation are:

- **Room name.** You can use local settings to select a room name such as Living Room for each Digital Entertainer Elite. Otherwise, they are named Digital Entertainer #1, Digital Entertainer #2, and so on, in the order in which they are installed. See “[Custom Setup](#)” on [page 6-1](#).
- **Follow me.** Move the programming from one room to another (press  **Home**, and select More > Follow me).
- **Send message.** Send messages from one Digital Entertainer Elite to another.
- **Monitor another Digital Entertainer Elite.** To monitor what is playing in another room, select More > Now playing, and use the left and right remote buttons to scroll between rooms.
- **Whole house audio.** You can have all the Digital Entertainer Elites play the same music simultaneously. Use Follow me, and select Everywhere; or use Follow me, and add rooms one at a time.

Chapter 4

Listening and Viewing

Your Digital Entertainer Elite can play a wide variety of digital media.

Listening to Music

The Digital Entertainer Elite provides easy access to the music files on an optional internal hard disk, on your computer hard disks, on external hard drives connected to a computer or to the Digital Entertainer Elite, or on other storage devices on the network.

To access music files, you need the following:

- The Digital Entertainer Elite.
- Music files available on your network or on an attached USB device.



Note: See [“Listening to Protected Music”](#) on page 4-3.

To listen to music:

1. Press **Music** on the remote, or press  **Home**, and then select Music.

This menu offers these selections:

- **Play something.** Play a random selection of shared music.



Tip: To play an entire album or list of songs, highlight the first song, and press **Play**. The rest of the songs will be played in the order shown.

- **Browse.** Browse digital music such as MP3. See [“Tips When Using the Remote Control”](#) on page 3-3 for tips.

- **Playlists.** Select and play a playlist.

	Note: Playlists should include only songs on the same server as the playlist itself, or the songs might not be identified correctly.
---	---

- **Internet Radio.** Browse Internet radio stations, or remove or add a station. See [“Playing Internet Media”](#) on page 4-13.

2. Select the music that you want to play.

	Tip: The Repeat button on the remote lets you repeat a selection.
---	---

When you browse and select a song, it is added to the list of playing songs. You can select the next song while you are listening to a song. To go to a song you selected, either press **Stop** before you select the song, or press **Next** repeatedly until you reach the song you want to hear.









	Tip: To save the list of playing songs, press i on the remote, select View Playlist, and then select Save.
---	--

There might be a difference between the time displayed when you are browsing a song and the time displayed when you are listening to the song. The time embedded in the song file is shown in the browser, while the actual length of the audio file (calculated by the Digital Entertainer Elite) is shown in the Now Playing screen.

Using the Remote Control When Music Is Playing

The following table describes how the remote control works when music is playing or paused. For a complete list of all remote control buttons, see [“NETGEAR Universal Remote Control”](#) on page 1-6.

Table 4-1. Remote Control When Music Is Playing

Button	When Music Is Playing	When Music Is Paused
	Resume playback.	Resume playback.
	Fast-forward.	Not available.
 or 9	<ul style="list-style-type: none"> Go to the next track. Press 9 to skip to the next item playing in a second session. For example, if you start music first and then photos,  skips to the next song, while 9 skips to the next picture. 	Go to the next track and start playing.
 or 7	<ul style="list-style-type: none"> Go back to the start of the current track. If already at the start of the current track, go to the previous track. Press 7 to skip to the previous item playing in a second session. For example, if you start music first and then photos,  skips to the previous song, while 7 skips to the previous picture. 	Go back to the start of the current track. If already at the start of the current track, go to the previous track and start playing.
	Show the Now Playing screen.	Show the Now Playing screen.
	Mute.	Not available.
	Pauses the music.	Not available.

Listening to Protected Music

You can listen to music stored on a Mac or PC.

Listening to Protected Music Stored on a PC

To play protected music stored on a PC, you need the following:

- A media player
 - Windows Media Player 11
 - iTunes for Windows
- The Digital Entertainer for Windows software on the same PC (required for iTunes playback only).

- Music files that are protected through Digital Rights Management. It is best if these protected files are stored in a single location on your network.

The protected music files must be in a shared folder to play on the Digital Entertainer Elite. For information about how to add folders containing shared music, see [“Enabling Access to Your Media Library”](#) on page 2-5.

Listening to Protected Music Stored on a Mac

To listen to protected iTunes music stored on a Macintosh:

1. Use the Configuration Assistant to share your music with the Digital Entertainer Elite.
2. Install iTunes on the PC that contains the Digital Entertainer for Windows software.
3. The first time you try to play an iTunes song, you will be asked to enter your iTunes password on the PC that contains the Digital Entertainer for Windows software.

Viewing Photos

The Digital Entertainer Elite finds the media files on an optional internal hard disk, on your computer’s hard disk, on other computers, on external hard drives, or on other storage devices on the network.

To view photos, you need the following:

- The Digital Entertainer Elite.
- Photo files available on your network or on an attached USB device.

To view photos:

1. Press **Pics** on the remote control, or press  **Home**, and then select Photos.
2. Browse by title, by folder, or by year. See [“Navigating with the Remote Control”](#) on page 3-1 for tips.
3. Press **Play** to view the selected photo and the rest of the listed photo as a slide show.

You can view photos in full screen or thumbnail mode.

- Press  **OK** to toggle between thumbnail or full screen mode.
- **Full screen mode.** Cycle through the photos. These are displayed in the same size and zoom level as they were last viewed.

- **Thumbnail mode.** View thumbnails of several photos at a time, so you can scroll easily. In thumbnail mode, you can use **Page Up** and **Down** to change the number of thumbnails displayed.



Tip: To play music while watching a photo slideshow, press **Music**, and start playing a song or playlist. While the music is playing, press **Home**, and then select the photos that you want to view with the music in the background.





Using the Remote Control While Viewing Photos

The following table describes how to use the remote control while viewing photos. For a complete list of all remote control buttons, see “[NETGEAR Universal Remote Control](#)” on page 1-6.

Table 4-2. Using the Remote Control to View Photos

Button	Action When Viewing Photos
	Speed up the slide show. The maximum speed depends on the size of the photos.
	Slow down the slide show.
 or 9	Go to the next photo. Press 9 to skip to the next item playing in a second session. For example, if you start photos first and then music, skips to the next picture, while 9 skips to the next song.
 or 7	Go back to the previous photo. Press 7 to skip to the previous item playing in a second session. For example, if you start photos first and then music, skips to the previous picture, while 7 skips to the previous song.
	Toggle to and from thumbnail view.
	Zoom in and zoom out in full screen mode. When viewing thumbnails, increase or decrease the size of thumbnails.
	Change the aspect ratio. The aspect ratio settings adjust the display of the photo for different types of television sets.
	Select another thumbnail in thumbnail view. Pan photo in full screen view.

Table 4-2. Using the Remote Control to View Photos (continued)

Button	Action When Viewing Photos
	The Rotate button rotates a photo. For faster results, switch to thumbnail view by pressing OK ; rotate the thumbnail; switch back to full photo view.
	Go back to the last browser menu.
	Jump to the music browser.
	Jump to the video browser.
	Jump to the photo browser.

Viewing Recorded Video

The Digital Entertainer Elite finds the video files on an optional internal hard disk, on your computer's hard disk, on other computers, on external hard drives, or on other storage devices on the network.



Note: Downloaded content from noncommercial sources might be of varying quality, and might not play back correctly.

To view recorded video files, you need the following:

- Digital Entertainer Elite.
- Video files available on your network or on an attached USB device.

Watching Recorded Video

To watch a video:

1. Aim the remote control at the digital media player, and do one of the following:
 - Press **Video**.
 - Press  **Home**, and select Video > Recorded Video.
2. Use the Recorded Video screen to browse videos. See [“Tips When Using the Remote Control” on page 3-3](#) for more information.
3. Select the video that you want to watch.

- To change the aspect ratio of the video to match your television screen, press the **Zoom** button on the remote control.
- To display information about the video, press the **i** button on the remote control. This option is available only when a video is playing.



Tip: Play plays the selected item, and then plays the rest of the items in the order shown on the screen.





Using the Remote Control When Recorded Video Is Playing

The following table describes how to use the remote control when video is playing. For a complete list of all remote control buttons, see “[NETGEAR Universal Remote Control](#)” on page 1-6.

Table 4-3. Using the Remote Control When Video Is Playing

Button	When Playing	When Paused	During Fast Forward or Rewind
	Fast-forward.	Slow motion.	Fast-forward faster.
	Rewind.	Not available.	Rewind faster.
	Go forward 30 seconds.	Single frame.	Go forward 10% of the video..
	Go back 30 seconds.	Not available.	Go back 10% of the video.
0-9	Jump in the file to 0%, 10%, 20%, ... 90% of the file.	Jump in the file to 0%, 10%, 20%, ... 90% of the file.	Jump in the file to 0%, 10%, 20%, ... 90% of the file.
	Toggle the aspect ratio.	Toggle the aspect ratio.	Toggle the aspect ratio
	Zoom the video in or out. Press Home twice to restore the original size.	Zoom the video in or out. Press Home twice to restore the original size.	Not available.
	Go back to the last video browser screen.	Go back to the last video browser screen.	Go back to the last video browser screen.
	Restart DVD (IFO/ISO) playback from the beginning of the disk.	Restart DVD (IFO/ISO) playback from the beginning of the disk.	Restart DVD (IFO/ISO) playback from the beginning of the disk.

Tip: When playing back DVD videos without integrated menus (Main Movie only), you can also use the onscreen DVD menu to turn subtitles on or off, change subtitle text, color and background, or to change the active audio track, for DVDs that contain more than one soundtrack.

1. To access the DVD screen, press **Menu** on the remote control, and then press  the **down arrow** to select a topic.
2. Press  **OK** to open the screen, and then press  the **down arrow** to select a setting.
3. Press  **OK** to accept the setting.

Using the USB Connection for Pictures, Music, or Video

You can connect up to two USB flash drives or a media player such as an iPod to a USB port on the front or rear panel of the Digital Entertainer Elite.

The Digital Entertainer Elite plays files stored in Windows (FAT, FAT32, NTFS), Macintosh, or Linux disk formats. It does not matter if you set up the music player on a PC or a Mac.



Note: Be sure to use USBv2 devices with your Digital Entertainer Elite. The limited bandwidth of the older USBv1 devices might interfere with the performance of your playback.

To play media with a USB connection:

1. Use the USB cable that came with your product to connect it to the USB port on the front or rear of the Digital Entertainer Elite.



Figure 4-1

The Digital Entertainer Elite scans the media, and then the media files are available for you to play on the Digital Entertainer Elite.

2. If you want to play the media on your USB device, press **Music**, **Video**, or **Pics** on the remote control, and then select the media files.



Note: When browsing media files on an iPod, note that iTunes uses an unusual file-naming convention to store music files on the iPod. The Digital Entertainer Elite can display only the folder names as they are saved on the iPod. You can find the files by using other criteria, such as artist or genre.

Installing and Using an Internal Disk Drive for Pictures, Music, or Video

The EVA9150 Digital Entertainer Elite comes with a pre-installed hard disk drive; the EVA9000 does not. The hard disk drive on the EVA9150 provides 500 GB of additional memory for storing your media files.

The pre-installed hard disk drive is completely set up and ready to use.

For both models, you can install and set up a hard disk drive that does not come with your system. For more information, follow the instructions in the next two sections.



Note: The Digital Entertainer Elite is equipped with an internal cooling fan to help protect the integrity of the internal disk drive.

For information on moving files to the hard disk, see [“Drag and Drop Media Files to the Internal Disk Drive”](#) on page 4-12.

Installing an Internal Disk Drive

To install a different hard disk drive on either Digital Entertainer Elite model, carefully follow these instructions.



Warning: The installation process formats the hard drive and erases all existing data. Before you begin, back up any existing data, if necessary.



Warning: Always power off the Digital Entertainer Elite using the on/off switch on the back of the unit before installing or removing the internal disk drive.

1. Power off the Digital Entertainer Elite using the on/off switch on the back of the unit.
2. Remove the disk tray as shown in the following figure.

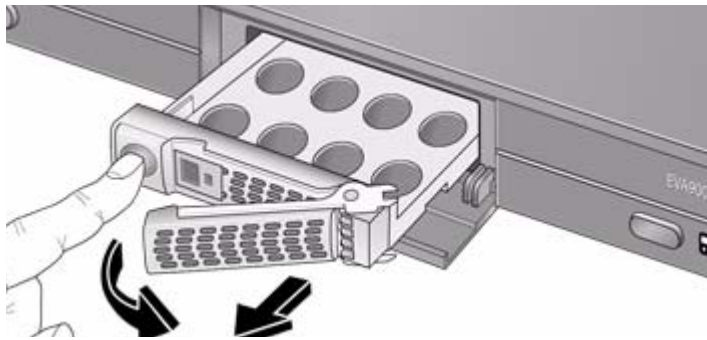

Figure 4-2

- a. Swing open the front cover.
 - b. Press to release the latch.
 - c. Pull out the tray.
3. For the EVA9150 only, remove the pre-installed hard disk from the tray.
 - a. Loosen and remove the four screws that secure the hard disk.
 - b. Set the four screws aside, and put the just-removed hard disk in a safe place.
 4. For greater security, set the lock inside the tray before installing the new hard disk into the tray (optional).

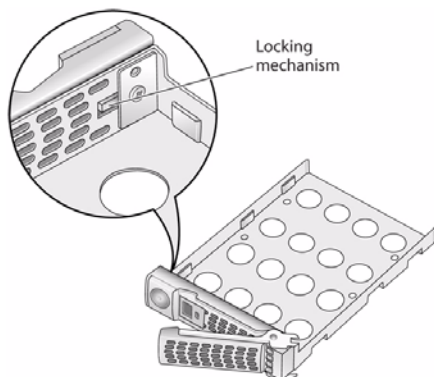

Figure 4-3

5. Insert the hard drive into the tray. Position the drive with the bottom facing out from the tray, and the connectors facing away.



Tip: If you set the tray lock, insert a push-pin or a paper clip into the round button to release the latch and open the tray (see [“Unlocking the Disk Drive Tray”](#) on page 7-11).

6. Use the four screws provided with the unit to secure the drive to the tray.

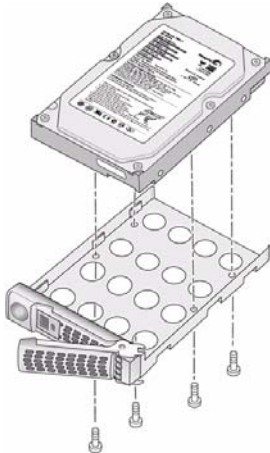

Figure 4-4

7. With the latch in the open position, slide the disk tray into the Digital Entertainer Elite completely, securing the latch and closing the door.

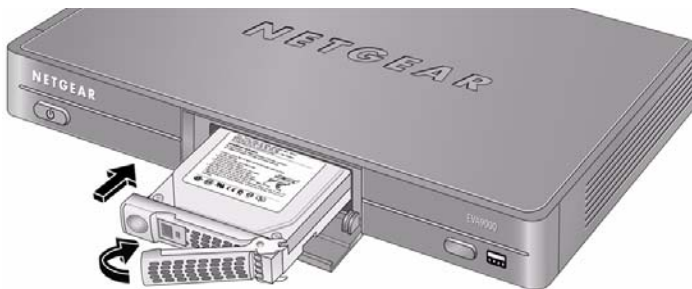

Figure 4-5

8. If the hard disk is not in EVA9000 format, you are prompted to format the drive. This process erases all data on the drive. See the following section for more information.

Setting Up the Internal Disk Drive



Warning: This step is necessary only when a hard disk is first inserted into the Digital Entertainer Elite. Formatting a disk erases all existing data. Back up any existing data before you begin, if necessary.

1. If you install a drive that is not in the EVA9000 or EVA9150 format, you are prompted to format the drive. Select **Yes** to format the disk, and continue to step 2.

If the disk is already in the required format, but you would like to reformat the drive, you can manually start the formatting process.

- a. Press  **Home**, and select **More > Supervisor functions > Hard Drive Tools > Format disk**.
 - b. Select **Yes** to format the disk. Wait for the format process to complete.
2. When the formatting process is complete, select **Yes** to copy your *persistent* data to the internal hard disk. The persistent data includes your media library and favorites, but does not include your media files, such as videos and music.



Note: The data source, such as a PC or USB drive, must be available over the network or through a direct connection.

3. Copy your media files to the internal disk drive as described in the following section.

Drag and Drop Media Files to the Internal Disk Drive

To copy your media files onto the internal disk drive, do the following:

1. Press  **Home**, and select **More > Supervisor functions > Advanced Settings > Power and Hard Drive**.
2. Scroll down to **File Sharing**, and select **Enabled**.
3. Enter a password (optional).
 - a. Select the password field and enter the new password using the drop-down keyboard.
 - b. Select **Done/OK** from the on-screen keyboard to save the changes.



Note: To disable the password, press the **CLR** button to clear all text.

4. On your PC, the EVA9000 or EVA9150 hard drive is listed with the networked devices:
 - On a Windows PC, go to Windows Network Neighborhood (Vista) or My Network Places (XP), and open “media on *EVA model name*” (which will be either EVA9000 or EVA9150).
 - On a Mac, go to Go > Network > *EVA model name* > Media

It might take a few minutes for the EVA9000 or EVA9150 drive to appear on your network.



Note: The EVA Data folder for the EVA9000 or EVA9150 drive contains an index of your media library and other system files. Do not modify the contents of this folder.

5. Use your mouse to drag media files to the media folder on the hard drive. NETGEAR suggests organizing the files into folders, such as *music* and *videos*.
6. To play the media on your internal hard drive, press **Music**, **Video**, or **Pics** on the remote and select the media files.
 - For improved video playback over a wireless connection, activate video buffering (if it is not already active), select More > Supervisor functions > Advanced Settings > Power and Hard Drive. Scroll down to Video buffering and select **All videos**. See “[Power and Hard Drive Tools](#)” on page 6-5 for more information.
 - To copy media files directly from a USB drive to the internal hard disk, select More > Supervisor functions > Hard Drive Tools > Manage data on disk. See “[Hard Drive Tools](#)” on page 6-3 for more information.

Playing Internet Media

To go to the Internet Media screen, press  **Home**, and then select Internet Media. The Internet Media menu offers these selections:

- **YouTube Video.** Playing YouTube videos may require that you have a PC running the Digital Entertainer for Windows software.
- **Internet Radio Player.** Browse and edit the list of Internet radio stations.



Tip: To add Internet radio stations more easily, use the Digital Entertainer Elite Web browser interface. Find your favorite station on your PC, copy its URL, and paste that into the browser.

- **Internet Channels.** Use the Internet channels option to access RSS multimedia feeds, including Internet podcasts. For more information, see “Internet Channels” on page 4-17.
- **Flickr Photos.** The Flickr browser loads 500 photos at a time. You can browse the photos that have been loaded, or load more photos. When browsing, you can press Play to start a slideshow from the selected photo onward, or press OK to view a single photo full screen. The Flickr photo viewer is identical to the regular slideshow viewer and all of the same buttons apply.
- **ReadyNAS Photos.** Internet Media also contains ReadyNAS photos, which allows you to view photos from your ReadyNAS attached storage device. To access these photos, sign in using your existing user name and password for ReadyNAS photos.



Viewing YouTube Content

You can use your Digital Entertainer Elite to view YouTube content and add items or publishers to your favorites lists.

To do so, you need the following:

- The Digital Entertainer Elite set up with access to the Internet through your network.
- A PC running the Digital Entertainer for Windows software. (This may be required to play some YouTube videos.)

To view YouTube content:

1. Press  **Home**, and select Video > YouTube, or select Internet Media > YouTube.
2. Select the option you want to use to retrieve YouTube content, and press  **OK**.
 - **Search.** Press **Caps Lock** to display the onscreen keyboard, and then use the arrow buttons on your remote control to enter a search term (tag). Your last search tag is displayed by default. Select OK on the onscreen keyboard to close the keyboard.
 - **Browse.** Browse categories of videos, such as action or animals.
 - **Featured.** Browse a list of top YouTube videos.
 - **Most Viewed.** Displays a list of popular YouTube videos.
 - **Top Rated.** Displays a list of videos rated highly by users.
 - **Recently Added.** Displays a list of videos recently uploaded to YouTube.
 - **My YouTube.** Choose this to sign in using your YouTube user name to access your playlists, online and local favorites, subscriptions, and history of watched videos.

The results of your search are displayed, with a preview of each item shown on the right when an item in the list is selected.

- Select the item you want to view, and press  **OK**. Or, press **Play** to play the currently selected video and queue the subsequent videos in the list.

The Digital Entertainer Elite begins playing the YouTube item.

	Note: Press the Menu button to view the video in full screen. You can also use the Zoom button to improve the picture quality when viewing YouTube content.
---	--

When you have finished viewing the item, you can save this publisher or this item in your favorites list for easy access in the future.

Using the Remote Control When Viewing YouTube Content

The following table describes how to use the remote control when YouTube content is playing. For a complete list of all remote control buttons, see [“NETGEAR Universal Remote Control” on page 1-6](#).

Table 4-4. Using the Remote Control When YouTube Is Playing











Button	When Playing	When Paused	During Fast Forward or Rewind
	Pauses the current video.	No action.	Pauses the current video.
	No action.	Resume playback.	Returns to play mode.
	Fast-forward.	Slow motion.	Press Fast-Forward again to increase the speed.
	Rewind playback.	Not available.	Press Rewind again to increase the rewind speed.
	Press twice to go to the previous video.	Press twice to go to the previous video.	Press twice to go to the previous video.
	Press twice to go to the next video.	Press twice to go to the next video.	Press twice to go to the next video.
	Stop the media that is currently playing.	Stop the media that is currently playing.	Stop the media that is currently playing.
	Toggle the aspect ratio.	Toggle the aspect ratio.	Toggle the aspect ratio.

Table 4-4. Using the Remote Control When YouTube Is Playing (continued)

Button	When Playing	When Paused	During Fast Forward or Rewind
	Zoom the video in or out. Press Home twice to restore the original size.	Zoom the video in or out. Press Home twice to restore the original size.	Zoom the video in or out. Press Home twice to restore the original size.
	Go back to the last YouTube browser screen.	Go back to the last YouTube browser screen.	Go back to the last YouTube browser screen.
	Toggles to and from full screen mode.	Toggles to and from full screen mode.	Not available.



Playing Internet Radio

You can use your Digital Entertainer Elite to access and play Internet radio programming and add items or publishers to your favorites lists.

To do so, you need the Digital Entertainer Elite set up with access to the Internet through your network.

	Note: Some Internet radio stations provide a low bit rate audio stream that your amplifier or receiver might not support. Try connecting the analog audio outputs of the Digital Entertainer Elite to the analog inputs of your home audio amplifier or receiver, and switch the device to that input when listening to a low bit rate Internet radio station.
---	---

To access and play Internet radio programming:

1. Press  **Home**, and select Music or select Internet Media.
2. Select Internet Radio, and press  **OK**.
 - **Browse station.** You can browse by title, genre, or quality. Use the up or down arrows and **Page up** or down to scroll through the list. A preview of each item is shown on the right when an item in the list is selected.
 - **Remove station.** Remove an Internet radio station from the list.
 - **Add station.** Add an Internet radio station to the list. You need to know the station's URL (Web address).
3. Select the item you want to play, and press  **OK**.

The Digital Entertainer Elite begins playing that item.

When you have finished playing the item, you can save this station in your favorites list for easy access in the future.



Tip: You can use the browser interface from the PC to add stations to the favorites list.

Using the Remote Control When Playing Internet Radio

Only the **Stop** button is available when Internet radio is playing. Press the **Stop** button to stop playing the Internet radio.

Viewing News and Weather

You can use the Digital Entertainer Elite to view news and weather.

To view news and weather, you need the Digital Entertainer Elite set up with access to the Internet through your network.

Viewing Weather

To receive local weather, you must enter your zip code. You can enter your zip code during installation or using Digital Entertainer Elite settings. (Press  **Home**, and select News/Weather.)

Internet Channels

Internet Channels uses Really Simple Syndication (RSS) for accessing regularly updated information such as news, podcasts, and blogs. Common sources are the major television networks and wire services, as well as many Internet websites and portals. Many of these Internet channels contain associated video, audio, or pictures.



To use the Digital Entertainer Elite to browse RSS feeds on your television, press  **Home**, and select Internet Media > Internet channels. The Digital Entertainer Elite includes several common feeds, and you can add your own. To add your own feed, select **Add new RSS feed**, and enter the URL (Web address) of the feed, as well as a descriptive title.

You can locate the RSS feeds on your computer and use the Digital Entertainer Elite browser interface to save the RSS feeds to view on your television.

Combining Different Media Sources

You can play both photos and audio media at the same time. For example, you can view a slideshow and play music.

- Start viewing photos, and then start the audio.
- You can start the audio first if you prefer.

Navigation commands from the remote control go to the media that you started last. The other buttons control the first media. For example, if you are playing music, and then start a slideshow, pressing **Pause** pauses the slideshow. You can press  to skip to the next song, and **9** to skip to the next picture. Or, press  to return to the previous song, or press **7** to return to the previous picture.

Viewing the Status of Multiple Digital Entertainer Elites

Use the Digital Entertainer application to view the status of any Digital Entertainer Elite operating in your network.

To do so, run the Digital Entertainer application:

1. From the Windows Start menu, select All Programs > NETGEAR Digital Entertainer for Windows > Digital Entertainer.

This icon  appears in the system tray when the Digital Entertainer for Windows software is running.

2. Click  to open the Digital Entertainer for Windows screen.
3. To access the Web browser interface, select Open.
4. Select Rooms > *name of Digital Entertainer Elite* to open a specific Digital Entertainer Elite.



Tip: You can also monitor what is playing on another Digital Entertainer Elite using the Now Playing screen on your TV. Use the right and left arrows to scroll between rooms and see what is playing in each.

Viewing Status

You can view the status of what is playing in each room. Click  and select Status. The Status screen opens.



Figure 4-6

The Status screen includes these buttons:

- **Power Off.** Stop media. This does not turn off the Digital Entertainer Elite.
- **Message.** Send a message for the Digital Entertainer Elite to display on the television screen.
- **Follow To.** Have media that is playing follow you to another Digital Entertainer Elite.
- **Lock.** For future use.

You can also right-click the Digital Entertainer Elite name to select the following additional options:

- **Play.** Play media in the selected room.
- **Control.** Opens a screen with buttons that control playback of the selected session, such as play, pause and skip.
- **Power off.** Stops the selected session.

Chapter 5

Fine-Tuning Your Experience

The topics in this chapter will help you fine-tune your experience with the Digital Entertainer Elite the following areas:

- Improving media library search results using tags and media art.
- Optimizing network performance to ensure that you get the best entertainment experience possible with your equipment.
- Taking precautions so that information such as personal photos sent over a wireless connection are not subject to snooping.
- Assuring that adequate parental controls are in place for using the digital media in your network.

Improving Media Library Search Results

To make browsing easier or to add media cover art, you can tag your media files with the Tag Tool.

Using the Tag Tool Application

Use the Tag Tool to enhance your file management on third-party devices, such as your mobile phone or MP3 player, as well as on the Digital Entertainer Elite. The Tag Tool works with these file formats: AVI, WMV, MPG, MP1, MP2, MP3, MKV, FLAC, ISO, and IFO. The Digital Entertainer Elite can read the existing tag information associated with your media files.



Note: You can use the Tag Tool to remove a tag for a file. Select Remove Tag or select Edit > Remove Tag.

You can use the Tag Tool to add or change the identification information stored in media files. For example, you can enter the artist name or rating.



Note: If you set the rating for a file, you can also control access to that file from the Digital Entertainer Elite Security screen.

To use the Tag Tool:

1. From the Windows Start menu, select All Programs > NETGEAR Digital Entertainer for Windows > Tag Tool.

The Tag Tool screen opens, as shown in the following figure.

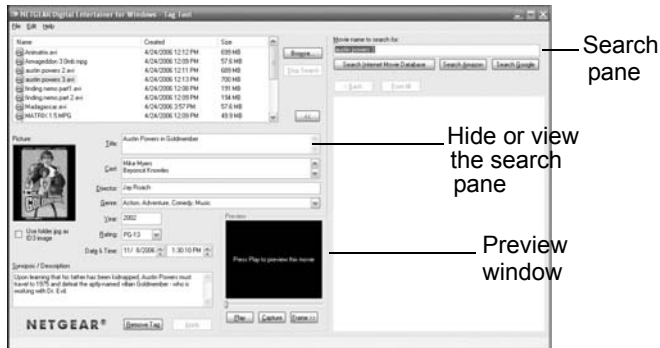

Figure 5-1

2. Locate the file that you want.
 - **File menu.** You can select File > Open to open a file.
 - **Browse.** Select Browse to view the files within a folder, and then select the file that you want.
 - **Preview window.** You can select Play to watch a preview.
 - **Search pane.** Enter the name of video in the Name, and then use the Search pane buttons: **Search IMDB**, **Search Amazon**, or **Search Google**. After you select a movie, you can select Form Fill to copy the information from the Web page into the Tag Tool screen.
3. Make the changes that you want, and then click **Apply** to save the tag.

Adding Cover Art

You can use the Tag Tool application to add cover art to files individually or in groups.

Capturing a Video Frame for Cover Art

You can use the Tag Tool to capture a single frame from the video to use as cover art for your video.

To capture a video frame:

1. Click **Play** in the Preview window.



Figure 5-2

2. When you find a frame that you like, click **Capture**.

The frame is captured into the Preview image.

Adding High-Resolution Album or Cover Art

You can add high-resolution album or cover art to a media file.

To add high-resolution art:

1. In the Tag Tool screen, click **Search Amazon** to locate the art. For even higher-resolution images, click **See larger image**.
2. Right-click the image of the album or cover art.
3. Select Copy, and then right-click to copy and paste the image into the Tag Tools Picture area.



Figure 5-3

You can also copy and paste any other image into the Picture area.

Adding Album Art to All the Songs in an Album

If you want to tag all the songs in an album with the same cover art, the songs must be in the same folder.

To add album art to all songs on an album:

1. Place all the songs from the album in a single folder.
2. Select any one of the songs from the album in the Tag Tool list box.
3. Click **Search Amazon**, and copy and paste the album art into the Tag Tool Picture area.
4. Select the Use folder.jpg check box. This saves your cover art picture into a file named folder.jpg in the album's folder. Both Windows Media Player and the Digital Entertainer Elite will recognize this as the album art for all the songs in the folder.

Using the Script Wizard to Automate Tasks

Use the Digital Entertainer Script Wizard to automate a variety of tasks. You can create three types of scripts:

- **Command script.**Creates a new script to automate the ways you use your Digital Entertainer Elite.
- **Video script.**Creates a new script that appears in the video browser of your Digital Entertainer Elite.
- **Audio script.**Creates a new script that appears in the audio browser of your Digital Entertainer Elite.

To create a script:

1. From the Windows Start menu, select All Programs > NETGEAR Digital Entertainer for Windows > Script Wizard.



Figure 5-4

2. Select the script type (command, video, or audio).



Figure 5-5

3. Click **New** to add an action from the list.



Figure 5-6

4. Select the options for the script action, if prompted, and then click **Next**.
5. Add additional actions, if necessary.

Understanding Home Networking

In recent years, home networks have become common. More and more, they include a variety of technologies that work together in ways that are not always obvious. The following topics identify common connection types, their speed, and security considerations.

- **Broadband Internet**

Your Internet connection speed is determined by your Internet Service Provider, as well as the connection speed of the sites to which you connect, and general Internet traffic. ADSL and cable modem connections are asymmetrical, meaning they have a lower data rate *to* the Internet (upstream) than *from* the Internet (downstream). A typical residential ADSL or cable modem connection provides a downstream throughput of about 1 to 3 megabits per second (Mbps). Newer technologies such as ADSL2+ and Fiber to the Home (FTTH) increase the connection speed to tens of Mbps.

- **Wireless**

Current-generation 802.11n wireless routers such as the NETGEAR WNR854T RangeMax NEXT Wireless-N Router provide wireless data throughput of up to 300 Mbps using technology called multiple input, multiple output (MIMO). MIMO uses multiple antennas to transmit multiple streams of data. The use of multiple (internal) antennas also provides excellent range and coverage. With the introduction of the newer WPA and WPA2 encryption and authentication protocols, wireless security is extremely strong.

- **Powerline**

For connecting rooms or floors that are blocked by obstructions or are distant, consider networking over your building's AC wiring. NETGEAR's Powerline HD family of products delivers up to 200 Mbps to any power outlet and connects to your devices and network using standard Ethernet cables.



Note: You need at least two Powerline HD adapters to make this type of connection in your network.

Data transmissions are encrypted for security, and you can configure an individual network password to prevent neighbors from connecting.

The Powerline HD family of products can coexist on the same network with older-generation XE family products or HomePlug 1.0 products, but they are not interoperable with these older products.

- **Wired Ethernet**

As Gigabit Ethernet ports become common on newer computers, wired Ethernet remains a good choice for speed, economy, and security. Gigabit Ethernet can extend up to 100 meters with twisted-pair wiring of Cat 5e or better. A wired connection is not susceptible to interference, and eavesdropping would require a physical connection to your network.

Assessing Your Speed Requirements

Because your Internet connection is likely to operate at a much lower speed than your local network, faster local networking technologies might not improve your Internet experience. However, many emerging home applications require high data rates. For example:

- Streaming HD video requires 10 to 30 Mbps per stream. Because latency and packet loss can disrupt your video, plan to provide at least twice the capacity you need, or add an internal hard drive to provide “buffering” for your connection.
- Streaming MP3 audio requires less than 1 Mbps per stream and does not strain most modern networks. Like video, however, streaming audio is also sensitive to latency and packet loss, so a congested network or a noisy link can cause problems.



Note: Actual data throughput varies. Network conditions and environmental factors, including volume of network traffic, building materials and construction, and network overhead, can lower actual data throughput rate.

Optimizing the Performance of Your Home Network

To get the best performance from your home network, you should optimize each portion of the network, as well as place files in the network where they will get the bandwidth their use will demand.

Optimizing Wireless Performance

The speed and operating distance or range of your wireless connection can vary significantly based on the physical placement of the wireless router. You should choose a location for your router that will maximize the network speed.



Tip: To find the best location, start the Network test (from the Supervisor Functions screen) running on the Digital Entertainer Elite, and then move the Digital Entertainer Elite and the wireless router. Monitor the Network test results to determine which location maximizes network speed.



Note: Failure to follow these guidelines can result in significant performance degradation or inability to wirelessly connect to the router. For complete range and performance specifications, see [“Technical Specifications” on page A-2](#).

The following list describes how to optimize wireless router performance.

- Identify critical wireless links.
If your network has several wireless devices, decide which wireless devices need the highest data rate, and locate the router near them. Many wireless products have automatic data-rate fallback, which allows increased distances without a loss of connectivity. This also means that devices that are farther away might be slower. Therefore, the most critical links in your network are those where the traffic is high and the distances are great. Optimize those first.
- Choose placement carefully.
For best results, place your router:
 - Near the center of the area in which your computers will operate.
 - In an elevated location such as a high shelf where the wirelessly connected computers have line-of-sight access (even if through walls).
- Avoid obstacles to wireless signals.
 - Keep wireless devices at least 2 feet from large metal fixtures such as file cabinets, refrigerators, pipes, metal ceilings, reinforced concrete, and metal partitions.
 - Keep the device away from large amounts of water such as fish tanks and water coolers.
- Reduce interference.
Avoid windows unless communicating between buildings.
Place wireless devices away from various electromagnetic noise sources, especially those in the 2400–2500 MHz frequency band. Common noise-creating sources are:
 - Computers and fax machines (no closer than 1 foot)
 - Copy machines and cell phones (no closer than 6 feet)
 - Microwave ovens (no closer than 10 feet)
- Choose your settings.
 - Use a scanning utility including those provided with the NETGEAR wireless adapters to determine what other wireless networks are operating nearby, and then select an unused channel.
 - Turn off SSID broadcast, and change the default SSID. Other nearby devices might automatically try to connect to your network several times a second, which can cause significant performance reduction.

Optimizing Your Network Bandwidth

As your network grows, it might consist of several segments of different networking technologies, each providing different throughput. In planning your network, you should first consider which devices will have the heaviest traffic flow between them. Here are some examples:

- A Digital Entertainer Elite in one room streaming high-definition video from a server in another room
- A storage device that is used for backing up your computers

Next, consider the throughput of your network devices. Where possible, use higher-speed technologies to make the heaviest-traffic connections with no lower-speed bottlenecks in the path.

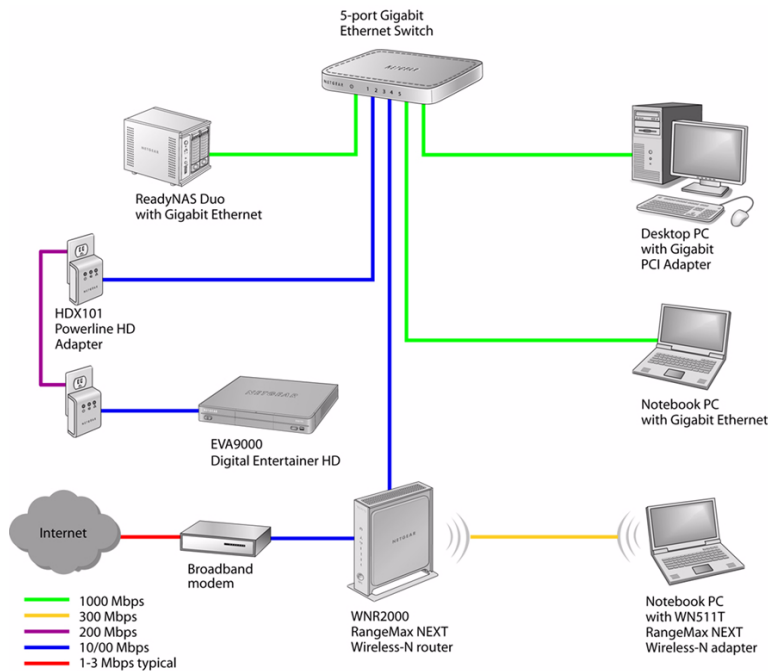

Figure 5-7

This illustration shows a sample network using multiple networking technologies. The two PCs with Gigabit (1000 Mbps) Ethernet adapters have a gigabit connection through the gigabit switch to the ReadyNAS Duo network storage unit with a gigabit connection. This connection should allow for extremely fast access to large files on the ReadyNAS™ Duo unit. The EVA9000 connected through a pair of Powerline HD adapters has access at the 200 Mbps speed of the Powerline HD connection. This is fine for any of the media files it will use over this connection and might be more suitable than running Ethernet cables to where the entertainment system is

located. Although any of the links in this example would be sufficient for high-traffic applications such as streaming HD video, the use of older devices such as 10 Mbps Ethernet or 802.11b wireless would create a significant bottleneck.

Optimizing Media File Performance

Video playback can be resource intensive. To avoid pauses in video viewing, select hard disk drives and network equipment designed to handle large files quickly. If you want to send video over a wireless network connection, new wireless technologies like those found in the NETGEAR RangeMax™ products are good choices. Not only do they operate at higher speeds, but they also sustain those speeds over greater distances.

File transfer speed depends on the following:

- Hard disk drive speed

SATA hard drives can be any of the following speeds: 4,500 RPM, 5,400 RPM, 7,200 RPM, 10,000 RPM.



Tip: For best performance, separate your media into their own set of folders. This maximizes performance of your PC and reduces the time needed to find media files.

- LAN connection speed

A Gigabit Ethernet connection through a gigabit switch provides the fastest LAN file transfer speed and gives the best performance.

NETGEAR HD Powerline adapters provide adequate bandwidth without the inconvenience of running Ethernet cables.

- Wireless communication speed

- 802.11b (11 Mbps,) is not recommended for video.
- 802.11g (54 Mbps) is not recommended for HD video.
- 802.11n is not recommended for high bandwidth HD video. However, when using 802.11n, the 5GHz band is usually less crowded and will likely provide better performance.
- If many wireless networks in your area are sharing the same channel, this can slow the speed of your wireless network. (The scanning utility built in to NETGEAR wireless adapters lists all wireless networks operating at your location along with the channel each is using.)

- If any 802.11b devices are powered on in an 802.11g network, they can cause the entire network to slow to 802.11b speeds.

Tips for Streaming Video

Use these tips for the best performance with streaming video or during file transfers to the Digital Entertainer Elite.

- Use a wired LAN connection to stream HD video.
- For streaming video, use no more than one wireless link. For example, do not wirelessly connect both the Digital Entertainer Elite and your computer with media to your router. Replace one of these wireless links with a wired connection.
- For playing music and viewing photos, wirelessly connecting both the Digital Entertainer Elite and the computer with media files should work fine.
- With a wireless 802.11g connection, you can stream standard-definition video, music, and standard-resolution photos reliably, although high network traffic and interference might cause some audio/video interruptions.
- You can use NETGEAR's Powerline HD product with a wired connection; it supports all but the most demanding HD streaming.
- Upgrade to a Dual Band 802.11n router such as the NETGEAR WNDR3300. Use the less crowded 5GHz band for video and keep your computers and other internet devices on 2.4GHz bands.
- For the EVA9000 model, add a hard drive (see [“Installing and Using an Internal Disk Drive for Pictures, Music, or Video”](#) on page 4-9) to improve playback results over wireless by using the hard drive to buffer playback.

Taking Precautions

Take precautions to secure personal data sent over wireless connections to your Digital Entertainer Elite. Also take precautions for monitoring content, if you wish to exercise parental control. See the following sections for information about doing this.

Access and Network Security

Use care when sharing media, and set up security in your home network to protect your privacy and prevent unauthorized access to your photos and media files.

When sharing media use the following precautions:

- Share *only* the folders containing media files. *Do not share your main hard drive or any folder containing programs or personal data.*
- Share media folders on a read-only basis (do not allow others to write to the folders.) unless recording to the folders.
- For maximum security, consider a storage device, attached to a network, dedicated to entertainment and media.

When using a wireless network:

- Use wireless security such as WEP, WPA, or WPA2. For more about wireless security, see [“Wireless Communications” in Appendix B.](#)
- Use a firewall or home router with Network Address Translation (NAT), which hides your in-home systems from the Internet.

Exercising Parental Control

You can block video files by rating, or block any files based on their location.

Block Video Files By Rating

To block video files using an MPAA or TV rating, mark the files with a rating and then select a rating level on your Digital Entertainer Elite:

1. Use the NETGEAR Tag Tool application to tag video files with an MPAA or TV rating. From the Windows Start menu, select All Programs > NETGEAR Digital Entertainer for Windows > Tag Tool.





Note: Files without tags are considered “NR” or Not Rated, the most sensitive and highest rating.



Note: Files restricted by rating do not have to be in the same folder.

2. Change the supervisor password on your Digital Entertainer Elite:
 - a. Press  **Home** and select More > Supervisor functions > Advanced Settings > Parental controls and security > Supervisor password.

- b. Enter the new password, and press  **OK**.

	<p>Note: Be sure you pick a password that is easy to remember, or store it in a safe place.</p>
---	--

3. Select More > Supervisor functions > Advanced Settings > Parental controls and security > Parental control.
4. Select the standard entertainment industry ratings such as G, PG, NR, and so on.



Users can access files with the selected rating or a lower rating (higher up on the menu), but cannot access files tagged with a higher rating. For example, if you select PG-13, all files with a PG-13, PG, TVPG or G rating are accessible at all times. However, files with TV-14, R, NC17, TVMA or NR (no rating set) are accessible only if you enter the supervisor password.

Select the NR rating to allow access to all shared media files.

	<p>Note: To temporarily suspend parental controls for 20 minutes and display blocked files, select More > Supervisor functions and enter the supervisor password. To re-establish parental controls, press the power button to turn the device off and back on.</p>
---	---

Block Files By Location

To block files by location, choose the shared folders that require a supervisor password:

1. Place the files in a shared folder.
2. Press  **Home** on the remote and select More > Supervisor functions > Advanced Settings > Parental controls and security > Share Restrictions.
3. Check the boxes next to the shared folders that require a supervisor password. Folders with a checked box can be accessed only with the supervisor password.
4. (Optional) Enter an additional password for each protected folder:
 - a. Press  **Home**, and select More > Supervisor functions > Advanced Settings > Servers and shared folders > Select which servers to scan
 - b. Highlight the shared folder that is password protected with parental controls.
 - c. Press  **Menu** and enter a username and password.
 - d. Select OK.

Chapter 6 Custom Setup and Supervisor Functions

Use the custom setup options to manually set up your Digital Entertainer Elite. Use the screens you access by selecting More > Supervisor functions to perform housekeeping tasks, run media library scans, and view system information. You can also use your Digital Entertainer Elite to access the desktop of a PC on your network.

Custom Setup

The Custom setup screen lets you manually connect the Digital Entertainer Elite to your network, and to share media files on your network so that the Digital Entertainer Elite can access them.

Use this screen to set up access to media files on your network that are on Linux systems or storage servers attached to the network.

To use Custom setup, press  **Home**, and select More > Supervisor functions > Setup Wizard. After you select a language and hear the audio welcome tune, you are offered a choice of Basic or Custom setup. The Custom Setup screen offers these options:

- **Select video mode.** Set the appropriate resolution for your TV.
- **Change room name.** If you have more than one Digital Entertainer Elite, you can select room names, such as living room, from the list of options to identify them. Or, you can enter a room name, using the onscreen keyboard.
- **Enter your ZIP code.** You can enter your zip code to receive news and weather for your local area.
- **Install Computer Software.** Next, you are prompted to use the installation CD (included with your Digital Entertainer Elite) on the computer where you store your media files. Follow the prompts to complete the setup of your Digital Entertainer Elite.
- **Scan for shared content.** Your Digital Entertainer Elite will scan your network for shared folders. Alternately, you can enter the name of a network workgroup to be scanned.
- **Data location.** Specify a writeable server location where your media library and other persistent data files can be stored.

Supervisor Functions Menu Screen

To go to the Supervisor Functions screen, press  **Home**, and select More > Supervisor functions. The Supervisor Functions menu screen offers these options:

- **Setup wizard.** Enter or change the settings for the Digital Entertainer Elite.
- **Advanced settings.** See [“Advanced Settings” on page 6-3](#).
- **Full scan for media files.** Rebuild the media library. This replaces current media files and adds newfound media files. A full scan takes significant time, depending on the number of folders you have designated for sharing.
- **Scan for USB attached media.** Check for media stored on devices such as an iPod or MP3 player that are connected to the Digital Entertainer Elite.
- **Scan for hard drive media.** Check for media stored on an internal hard drive device installed in the Digital Entertainer Elite.
- **Hard Drive Tools.** Format the drive or verify the health of the drive. See [“Hard Drive Tools” on page 6-3](#).
- **Network test.** Measure the data transfer rate between devices on your network and your Digital Entertainer Elite.
- **Update.** Check for firmware updates for the Digital Entertainer Elite on the NETGEAR website, or update the firmware from a file on a USB storage device. See [“Updating the Firmware” on page 7-1](#) for more information.



Warning: Be sure that power to your Digital Entertainer Elite unit is not interrupted during the firmware update process. Failure to observe this precaution can permanently damage the unit.



Note: Following a firmware update, you may need to reload your media library into the Digital Entertainer Elite from the backup location.

- **System Information.** See [“System Information” on page 6-9](#).
- **Restart.** Restart the Digital Entertainer Elite.

Hard Drive Tools

If an internal disk drive is installed, use the Hard Drive Tools screen to format the drive or verify the health of the drive. You can also manually copy individual files to the drive.

To access these options, press  **Home**, and select **More > Supervisor functions > Hard Drive Tools**.

- **Manage data on disk.** Copies a single media file or a complete folder from another source drive, such as a PC or USB drive, to the internal hard drive.
- **Format disk.** Formats the disk for use with your Digital Entertainer Elite. The format process erases all existing data. Before you begin, back up any existing data, if necessary.
- **Standard disk check.** Checks the consistency of the disk file system. Use this option if you have trouble copying or reading a file. The standard disk check can take up to 30 minutes. The Digital Entertainer Elite cannot be used until the process is complete.
- **Extensive disk check.** Checks the entire disk surface for bad blocks. Use this option if you have trouble copying or reading a file. The extensive disk check can take up to several hours. The Digital Entertainer Elite cannot be used until the process is complete.
- **Unmount drive.** Unmounts and disables the drive from the Digital Entertainer Elite. This option is used to replace a disk. After the disk is unmounted, replace the hard disk following the instructions in “*Installing and Using an Internal Disk Drive for Pictures, Music, or Video*” on page 4-9. NETGEAR recommends that you power off the Digital Entertainer Elite whenever removing or installing a hard drive.
- **Drive information.** Displays information about the drive including capacity and percentage of storage space used.



Tip: For more information, refer to “*Installing and Using an Internal Disk Drive for Pictures, Music, or Video*” on page 4-9.

Advanced Settings

The following options are available to customize your Digital Entertainer Elite.

Display and Screensaver

- **Display type.** Select the display you prefer. The default is North America.
- **Display mode.** For a high-definition TV, select the appropriate resolution.

- **Aspect ratio.** When set to Normal, the aspect ratio defaults to the same setting as the content you are viewing.
- **Smooth scroll.** This setting affects the appearance of the Digital Entertainer Elite menus.
- **Brightness, Contrast, Hue.** Although you can adjust these settings on the Digital Entertainer Elite, it is best to leave them at the default settings of 50, and adjust the features on your TV.
- **Screen saver.** You can set the interval after which a screen saver will protect your TV from image burn-in. You can use the Image option to use a picture from your library as your screensaver.
- **Skin settings.** Choose one of the built-in skins, or backgrounds, for the onscreen menus.

To Add a Skin:

1. From the main menu, select More > Supervisor functions > Advanced Settings > Display and screensaver.
2. Navigate to Skin settings. The default skin setting is called FlareHD and is stored on the Digital Entertainer Elite flash. Click the **Save skin** button to export the skin to the Data save location folder (set in the Advanced Settings > Media library management screen).
3. Navigate to the machine, NAS, or USB share that you are using as your data save location. Locate the Skins subfolder. Underneath that are subfolders for each defined skin. A subfolder called FlareHD was created in the previous step.
4. Uncompress the skin you want, and put it in its own subfolder.
5. From the main menu, select More > Supervisor functions > Advanced settings > Display and screensaver.
6. Select the new skin from the drop-down list, and press the **Back** button. The skin displays on your screen.



Warning: Loading an invalid skin can cause your Digital Entertainer Elite to become unusable. If this occurs, you will need to restore factory defaults using the button on the rear panel of the unit.

7. Audio and Slideshow

Use these options to customize your audio and image experience:

- **Digital Audio Surround Output.** You should leave these settings at the default value (Stereo) unless your system is capable of processing one of the surround sound formats. To enjoy surround sound playback, set the option to Passthrough.

- **Volume level lock.** The default value, not fixed, allows you to control the volume using the Volme Up/Down buttons. Other values let the Digital Entertainer Elite set the audio level. When the volume is fixed, the volume keys on the Digital Entertainer Elite remote do not operate. This is useful if you use the volume control of your home theater system and want the Digital Entertainer Elite to always use the same volume level.
- **Slideshow transition.** Select the transition style you prefer for your slideshows.
- **Image zoom.** Select Full image to see your images actual size, or Fill screen to make images fill the screen. Low-resolution images might appear pixillated when displayed to fill the screen.
- **Minimum image size.** The Digital Entertainer Elite does not include images smaller than the specified file size.

Power and Hard Drive Tools

The Power and Hard Drive screen includes additional settings for hard drive and power features.

To access these options, press  **Home**, and select More > Supervisor functions > Advanced > Power and hard drive.

- **Fan override.** Specifies when the hard drive cooling fan runs. The default is **auto**.
- **Standby:** Select the number of minutes or hours that should pass before the device enters standby mode. The default is **Never**.
- **Power Off:** Select the number of minutes or hours that should pass before the device is powered off. The default is **Never**.
- **Remote power key:** Select if the power button should put the device in **Standby** or **Power Off** the unit. The default is **Standby**.
- **File Sharing.** Enable File Sharing to allow drag and drop of media files. See [“Drag and Drop Media Files to the Internal Disk Drive” on page 4-12](#) for more information. The default is **Disabled**. When File Sharing is enabled the system will not enter Power Off mode automatically. This option is available only if a hard drive is installed.
- **Video buffering.** Use video buffering to improve the performance of video playback, especially over a wireless connection. Select **All Videos** for best performance with a wireless connection. This option is available only if a hard drive is installed.
- **Disk buffer size.** Select the amount of disk space used for the video buffer. Use the up and down arrow buttons to increase or decrease the buffer size setting. This option is available only if a hard drive is installed.

- **Clear buffer history.** Clears the data stored in the video buffer. This option is available only if a hard drive is installed.

See also [“Hard Drive Tools” on page 6-3.](#)

Network Connection

To go to the Network connection screen, press  **Home**, and select More > Supervisor functions > Advanced Settings > Network connection. You can select from three types of network connections to your Digital Entertainer Elite:

- **Wired.** Ethernet local area network (LAN) connection.
- **Wireless.** Wireless 802.11b, 802.11g, or 802.11n connection.
- **Standalone.** USB device connected directly to your Digital Entertainer Elite.

Other Advanced Settings

Other features you can access from the Advanced Settings screen include:

- **Servers and shared folders.** Set up shared media files available for the Digital Entertainer Elite. See [“Setting Up Network Shares” on page 6-7.](#)
- **Parental controls and security.** Set up parental controls See [“Exercising Parental Control” on page 5-12.](#)
- **Media library management.** Manage your media library. See [“Media Library Management” on page 6-7.](#)
- **Language.** Select a language for the Digital Entertainer Elite onscreen menus.
- **Time and location.** Specify your location and time zone, and synchronize your Digital Entertainer Elite to a time server.
- **Other.**
 - **Folder browsing:** Enable or disable folder browsing. Enabling this option displays the complete folder tree starting at the top level. Enable “Live” folder browsing to display all network locations and scan each folder as you select it, adding any new media it finds to the media library.
 - **SACK Processing:** SACK audio processing is used for debugging only.
 - **Media art display:** Specifies the size of media art. Smaller files appear fast on the screen.
 - **Pop-up help.** Enables or disables the pop-up help system. Pop-up help is enabled by default.

- **YouTube direct playback.** Enables or Disables higher quality video directly from YouTube without using a Windows PC. Since some YouTube clips are not available using this method, error messages may appear.
- **Disable UPnP setting.** Use this to disable UPnP support in the event you are experiencing compatibility problems with UPnP devices or servers on your network.
- **Restore factory defaults.** This resets all the options to the default values as of the last installed firmware, and requires a system restart.
- **Data save location.** Specify where the media library, photo thumbnails and other data will be saved.
- **Data backup and restore.** Save your settings or restore the Digital Entertainer Elite to its factory default settings.

Setting Up Network Shares

Network shares are shared folders that can be seen throughout your network. You can specify which shared folders you want the Digital Entertainer Elite to check when it looks for media files.

To go to the Network Shares screen, press  **Home**, and select More > Supervisor functions > Advanced Settings > Servers and shared folders. The Network Shares screen offers these options:

- **Build network shares list.** Scan the network for all shared folders.
- **Select which servers to scan.** Select which shared folders the Digital Entertainer Elite should check when it scans for media files.
- **Add network share.** Enter the name of a hidden server, or add a password to a server. A hidden server does not broadcast its network name.

Media Library Management

The media library is a list of media that the Digital Entertainer Elite has found in shared folders on the network. There are two versions of your media library: One resides on the Digital Entertainer Elite, and the other is a backup, located in the data save location you specify. The backup library can be saved to a device on your network, or to an external device. Each time the Digital Entertainer Elite searches for media, it can save a new library. If there is a library, the Digital Entertainer Elite powers up faster in the event of a network problem or power outage.

To go to the Media library management screen, press  **Home**, and select More > Supervisor functions > Advanced Settings > Media library management. The Media library management screen offers these options:

- **Data save location.** Specify where your backup library should be saved.

- **Load library.** Load the media library.
- **Save library.** Save the media library to a new location, either on your network or on an external device. This creates a backup library.
- **Auto load on power-up.** If this option is on, the Digital Entertainer Elite loads the backup library following a power failure.
- **Auto save after scan.** Immediately after new files are scanned, the backup library is updated to the version on the Digital Entertainer Elite.
- **Daily auto-scan.** Set the Digital Entertainer Elite to scan your files every day at the specified time, or you can disable this option.



Warning: This option requires your computer to be on and the shared files available at the specified time. If your computer is in sleep, standby, or any mode other than on, the scan will find no shared files, and your library will contain no media.
To avoid this, you can disable Daily auto-scan, or leave the computer on, or enable the computer Wake on LAN feature so that your computer is activated by the scan.

- **Show file details.** This option is for use in detecting invalid files and should be left off unless you are instructed to use it by NETGEAR support personnel.

More... Settings

The following settings are available in the More screen:

- **Quick scan for media files.** Look for new media files and add them to the media library.
- **Now playing.** Display the audio and video media that is currently playing.
- **Follow me.** To use this feature you must have more than one Digital Entertainer Elite installed. Selecting Follow me lets you direct the media that is playing to another Digital Entertainer Elite in a different room. See also [“Using Multiple Digital Entertainer Elites” on page 3-7](#).
- **Send message.** You can select a message to send to another Digital Entertainer Elite in a different room. To use this feature you must have more than one Digital Entertainer Elite installed.

- **Hot key binding.** You can set up the number keys on the remote control as hot keys to perform specific tasks. For example, you could press a number button when the TV is off to play music without using the onscreen menus. See [“Supervisor Functions Menu Screen” on page 6-2.](#)
- **Supervisor Functions.** See [“Supervisor Functions Menu Screen” on page 6-2.](#)

System Information

System information is useful for troubleshooting network problems or technical support.

To go to the System Information screen, press  **Home**, and select More > Supervisor functions > System Information. The System Information screen displays information about free memory, version information (kernel and firmware), dynamic RAM information, network information (LAN), IP address, MAC, broadcast information, and gateway.

Setting Up Hot Keys

You can set up the number keys on the remote control as hot keys to perform specific tasks. For example, you could press a number button when the TV is off to play music without using the onscreen menus.

To set up a hot key:

1. Press  **Home**, and select More > Hot key binding.
2. Select the key on the remote control that you want to program.
3. Select an action from the list for this hot key.

To use the hot keys when the television is off, turn on the Digital Entertainer Elite, and then press the hot key.

Using PC Access

To use this feature you must have a Windows-based PC running the Digital Entertainer for Windows software. PC Access lets you use the remote control and TV to view and access features on your PC such as browsing the Internet or checking e-mail.

To use the Digital Entertainer Elite PC Access feature:

1. Click the Digital Entertainer for Windows system tray icon  on your PC to open the Digital Entertainer application.

2. Select the Allow remote access to this PC check box.

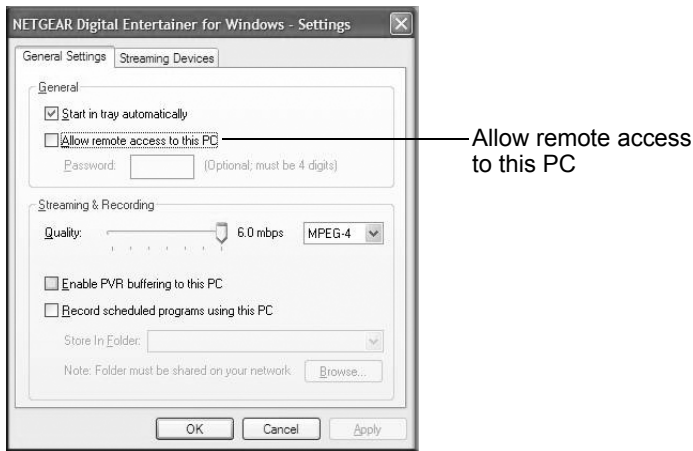









Figure 6-1

3. To access your PC functions, press **Home**, and select More > PC access, and select your PC from the list in the Access PC screen.
4. When the desktop for your PC appears on the TV, use the remote control to access the PC from your Digital Entertainer Elite.

Table 6-1. Remote Control PC Access Is Enabled

Button	Action
	Backspace
	Nudge mouse
	Switch (Alt+Tab)
	Exit PC Access
	Back Tab
	Close program (Alt + F4)
	Back (Alt+Left Arrow)

Table 6-1. Remote Control PC Access Is Enabled (continued)

Button	Action
	Tab
	Next (Alt+Right Arrow)
	Left mouse-click
	+ Zooms in - Zooms out
	Toggle Alt key. Changes the Alt key status from pressed to not pressed and back. Use this to access an application menu.
0-9	Use numbers to enter letters.
	Toggle keyboard. Press Caps Lock to display or hide the onscreen keyboard.
	Select program.

Chapter 7

Maintenance and Troubleshooting

Resetting to Factory Defaults

There are 3 ways to restore factory defaults:

- You can use the menus to reset to factory defaults. Press **Home**, and select More > Supervisor functions > Advanced Settings > Restore factory defaults.
- You can use the Reset button on the rear panel of the Digital Entertainer Elite to reset to factory defaults. While the Menu is active (you are not playing video), use a pen or paperclip to tap the Reset button 3 times.

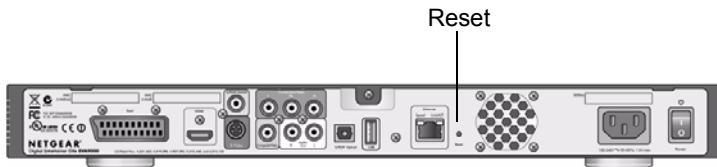

Figure 7-1

The television screen displays a message asking if you want to restore default settings.

- Power off the unit from the rear power switch, then power on the unit. Wait for the LED to blink orange, then press and hold the Reset button. The LED will begin blinking blue signaling that factory defaults are being restored, and then the unit will restart.

For information about factory default settings, see [“Default Settings” on page A-1](#).

Updating the Firmware

To update the firmware on your Digital Entertainer Elite, press **Home**, and select More > Supervisor functions > Update.

- To check for firmware updates for the Digital Entertainer Elite on the NETGEAR website, select Update from the Internet, and follow the onscreen prompts.

- If the firmware file is located on a USB storage device, connect the device to the USB port of your Digital Entertainer Elite, and select Specify a location. Uncompress the file .zip file, if necessary. The .img firmware file must be on the top level (root) of the device. If more than one file is on the device, you are prompted to select a file.
- When the update is complete, the Digital Entertainer Elite restarts.



Warning: Be sure that power to your Digital Entertainer Elite unit is not interrupted during the firmware update process. Failure to observe this precaution can permanently damage the unit.



Note: Following a firmware update, you need to reload your media library into the Digital Entertainer Elite from the backup location.

Playing Media

If the Digital Entertainer Elite cannot play media or music, check to see if the file is protected. Windows Media Player 11 is required for Windows XP and Vista users to play protected files. See the Microsoft documentation for these products.



Note: If you use Windows Media Player 11, place protected media files in one folder, and use Windows Media Player to share only that folder. Then use the Configuration Wizard to share all other folders.

Firewall Port Settings

The built-in Windows firewall opens ports to communicate with the Digital Entertainer Elite. For other firewalls, you might need to open these ports:

- TCP: 49156, 49157, 49158, 49159
- UDP: 49152, 49153, 49154, 49155

If you are using a Windows PC to share media content, allow access to the following ports: 139 TCP, 445 TCP, 137 UDP, and 138 UDP for file-sharing services.

If you are using Windows Media Player to share media from Windows, configure your desktop firewall to allow ports 10243 TCP and 10280–10284 UDP.

If you are using the UPNP Framework under Windows XP, configure your desktop firewall to allow port 1900 UDP and 2869 TCP. For more information see <http://support.microsoft.com/kb/886257/>.

Accessing Your Digital Media

The following sections provide some suggestions for accessing digital media with Windows, Macintosh OSX, and Linux.

Windows System Passwords

If your system requires a password on startup, you need to use one of these access methods:

- Recommended: Enable guest access on PCs that have a startup password. From the Windows Start menu, select Settings > Control Panel > User Accounts, and enable guest access.
- Manually enter passwords on your Digital Entertainer Elite.
- Remove the password from the main administrator account.

Macintosh OSX

Turn off the Macintosh firewall, and then select the sharing icon from system preferences.

1. Click **Firewall**, select Stop, and verify that “Firewall off” is displayed.
2. Select the sharing icon from system preferences, and select the Windows Sharing check box. Make sure that “Windows Sharing On” is displayed.

Once the system is up and running, for better security you can configure your OSX firewall to allow file access while blocking other network ports. For file sharing you must allow access through TCP ports 139 and 445, and UDP ports 137 and 138.

Linux

You need to load and install a Samba server.

- On Redhat 9 systems, click the **Red Hat** button, and select System Settings > Server Settings > Samba Server. Click **Add** in the dialog box that displays.
- On other systems, you might need to install the Samba server (smbd) manually and modify the samba configuration file (/etc/smb.conf on most systems; select the man smbd check box). If Samba is not installed, see <http://www.samba.org>.

Error Messages

The following table describes error messages and recommended actions when they occur.

Table 7-1. Error Messages

Message	Description and Action
Please configure the program guide location.	You need to enter your zip code to receive local news and weather.
Network Performance Insufficient.	The network throughput is not high enough to handle the file type specified, such as playing high-definition video over a wireless network. See “Optimizing the Performance of Your Home Network” on page 5-7 for more information.
Unable to play this media. The media format is not supported, or the location is not accessible.	The media format is not supported by the Digital Entertainer Elite, or the file could not be opened or might no longer be available. <ul style="list-style-type: none"> • Play a supported media file. • Check the network connection. • Verify the existence of the file. • Verify the PC or server is powered on. • Check the access permissions on the file and folder. • Verify that the file format and encoding are supported. See “Supported Media File Formats” on page A-2 for more information.
Unable to play this media. The media could not be opened, or the location is not accessible.	The file cannot be opened or might no longer be available. <ul style="list-style-type: none"> • Check the network connection. • Verify the existence of the file. • Check the access permissions on the file and folder.
Unable to play this media. The media is protected, and a license could not be obtained.	<ul style="list-style-type: none"> • The file is protected by Windows Media DRM, and the license for the file is expired, or invalid, or was not granted. • Verify that the file is playable from Windows Media Player.
Unable to play this media. There are insufficient resources to open or play the media.	Restart the Digital Entertainer Elite. If the problem persists after restarting the Digital Entertainer Elite, then the media dimensions or encoding is not supported.
Unsupported video - may not play correctly.	The video is a DIVX 3 video. Some DIVX 3 videos do not play back correctly on the Digital Entertainer Elite.
Unable to play this station.	The format of the selected Internet radio station is not supported. The Digital Entertainer Elite supports only MP3 streaming audio formats for Internet radio playback.
Error loading picture. Photo format is not supported.	The photo is not a JPEG, TIFF, BMP or PNG, or the dimension, encoding, or color space of the photo is not supported.

Table 7-1. Error Messages (continued)

Message	Description and Action
Error loading picture. Photo does not exist.	The file cannot be opened or might no longer be available. <ul style="list-style-type: none"> • Check the network connection. • Verify the existence of the file. • Check the access permissions on the file and folder.
Error loading picture. Photo is too large or has encoding errors.	The dimensions of the photo are too large for it to be loaded, or the file is invalid.
Error loading picture. Photo could not be read.	The file exists, but an error occurred when it was accessed. <ul style="list-style-type: none"> • Check the network connections. • Check access permissions on the file and folder. • Check that the photo is viewable on a PC.
Error loading picture. Access denied reading the photo.	<ul style="list-style-type: none"> • The file exists but does not allow read access to the Digital Entertainer Elite. • Check access permissions on the file and folder.
Subtitles not available.	The external subtitles for a video do not exist or could not be loaded. The subtitles might be in an unsupported format. Supported subtitle formats are SRT, SMI, SAMI, SUB, and TXT.

Troubleshooting Tips

Here are some tips for correcting simple problems that might prevent you from connecting to the Digital Entertainer Elite.

Table 7-2. Connecting to the Digital Entertainer Elite

Problem	Solution
<p>I turned on my Digital Entertainer Elite for the first time, but I do not see anything on the screen.</p>	<ul style="list-style-type: none"> • Check all cables to make sure that they are connected correctly, and be sure that you are using the correct input on your TV. • Check that your TV's input selector (sometimes called TV/Video button) is set to the correct input. • If you still do not see anything, press TV Mode on the remote control to change the video mode. Make sure to pause for 3 seconds between button presses to allow the Digital Entertainer Elite to change video modes.
<p>The Digital Entertainer Elite does not respond to the remote control.</p>	<p>Check the LED on the front panel of the Digital Entertainer Elite to make sure that the power is on. Make sure that the television is turned on. The LED on the remote control should flash when you push a button.</p> <ul style="list-style-type: none"> • If the LED does not flash, and the batteries are working, then the remote might be faulty. • If the LED does flash, reset the Digital Entertainer Elite. • Press the  DE button on the remote and try again.
<p>The Digital Entertainer Elite does not find my network.</p>	<ul style="list-style-type: none"> • For wireless networks, make sure that the wireless network name (SSID) and security settings of the Digital Entertainer Elite and media server match exactly. • Use the Digital Entertainer Configuration Wizard, and check the settings. On the Windows Start menu, select All Programs > NETGEAR Digital Entertainer for Windows > Configuration Wizard.
<p>Some files do not play or cause the system to reset.</p>	<p>The Digital Entertainer Elite might not support the audio or video format used in the file. For information about what files are supported, see "Supported Media File Formats" on page A-2.</p>
<p>The Digital Entertainer Elite does not find the server.</p>	<ul style="list-style-type: none"> • Make sure that the computer and the Digital Entertainer Elite are connected to the same network and turned on. • If you do not use DHCP on your network, you must set the IP address of the Digital Entertainer Elite in the range of addresses on your network. See "IP Address" on page 7-9. • Use the Configuration Wizard to check the settings. On the Windows Start menu, select All Programs > NETGEAR Digital Entertainer for Windows > Configuration Wizard.

Table 7-2. Connecting to the Digital Entertainer Elite (continued)

Problem	Solution
Some files, songs, or videos are not showing up even though others are.	Check the file permissions for those items, and make sure that they have read access allowed for everyone.
The server cannot be found in a Windows domain.	<p>If the PC where the Digital Entertainer for Windows software is running is a member of a Windows domain:</p> <ol style="list-style-type: none"> 1. Make sure that you are connected to the domain (either by being on the same network, or by using a VPN connection), and then restart folder sharing in Windows Media Connect. 2. If this is not possible, uninstall the Digital Entertainer for Windows software, and reinstall it using a local user account. Then set up sharing with the Digital Entertainer for Windows software while logged in with this local user account.

Network Connections

The following sections provide recommendations for how to troubleshoot network connections.

Ethernet LAN Connection

The Digital Entertainer Elite expects to be connected to a hub, switch, or router using a standard Ethernet cable. If you connect to your network using Ethernet, the link LEDs on the back of your Digital Entertainer Elite and on your hub or router should both be on. If they are not lit, try the following:

- Make sure that the Ethernet cable connections are secure at the router and at the hub or workstation.
- Make sure that power is turned on to the connected hub or workstation.
- Make sure that you are using a standard Ethernet cable and not a cross-connect cable.

Troubleshooting a Wireless Network Connection

If you did not connect an Ethernet (LAN) cable, the Digital Entertainer Elite scans for wireless networks. If it does not find your network, check the following items:

- The Digital Entertainer Elite cannot connect to the wireless network while it is connected to the Ethernet network. Disconnect your Ethernet cable.

- Move the Digital Entertainer Elite closer to the wireless access point or router. See [“Wireless Range and Interference”](#) on page 7-8.
- If there is more than one network in your area, then you must know the network name. The network name is also called the service set identifier (SSID).
- If your access point or router does not broadcast its SSID, then it is a hidden network, and the Digital Entertainer Elite cannot detect it.
 - The SSID, and passwords keys are case-sensitive. For example, NETGEAR is not the same as Netgear.
 - You must manually enter your wireless settings as described in [“Setting Up Network Shares”](#) on page 6-7.

For detailed information about wireless networks, see [“Wireless Networking Basics”](#) listed in [Appendix B, “Related Documents.”](#)

Wireless Range and Interference

Wireless networks have one or more access points or routers that send out wireless signals. The distance that the signal travels is the wireless range. Interference can block a wireless signal.

The strength and range of the wireless signal depend on the equipment used. As you move the Digital Entertainer Elite away from an access point or router, you could lose your wireless connection.

The following can cause interference and prevent you from connecting to a wireless network:

- Large metal surfaces
- Microwave ovens
- 2.4 GHz cordless phones
- Aquariums or large fish tanks
- Walls built with concrete or metal

Wireless Networking Tips

Wireless networks can be subject to intermittent outages due to interference and other environment factors such as distance and construction materials.

Here are some tips for setting up a more robust wireless network for your media:

- A wireless 802.11g or 802.11n network can generally support at most a single HD transmission. For best results with HD video, use a wired network.

- NETGEAR recommends using a wireless 802.11 n router with 5GHz capability such as WNDR3300. For best results, do the following:
 - Use a separate SSID for the 5GHz band.
 - Set the Digital Entertainer Elite to use the 5GHz SSID.
 - Run the “Network Test” and make sure the Digital Entertainer software is running on a PC. Try to reposition the router and the Digital Entertainer Elite to maximize throughput to the PC. Readings above 60Mbps should be readily achievable.
- When using 802.11g or 802.11 n, make sure that there are no 802.11b devices connected. Having any 802.11b devices connected reduces the overall throughput of your network even if the 802.11b devices are not active.
- In environments with lots of wireless networks you might have better results with power line networking.

IP Address

If the Digital Entertainer Elite does not receive a valid IP address, try the following:

1. Verify that a working DHCP server is on your network. Computers on the network should get IP addresses in the correct range.

If the Digital Entertainer Elite is set to use DHCP and fails to obtain an IP address from the server, it resorts to a default IP address of 127.0.0.1. You can use a static IP address if there is a problem connecting to the DHCP server.

2. If you are using a wireless network, verify that the Digital Entertainer Elite is associated with the correct SSID. To display the SSID, follow the instructions in [“Setting Up Network Shares” on page 6-7](#).
3. If you are using a secure wireless network, verify that the security settings, such as WEP or WPA, on the Digital Entertainer Elite, match the settings on your access point. For information about wireless security, see “Wireless Networking Basics” listed in [Appendix B, “Related Documents.”](#)

Connecting to a Server

If the Digital Entertainer Elite cannot find the correct server, try the following:

1. Verify that the Digital Entertainer Elite and the PC running the Digital Entertainer for Windows software are on the same subnet.

For example, you could use a subnet with IP addresses in the range of 192.168.0.x for both the Digital Entertainer Elite and the PC, with a subnet mask of 255.255.255.0.

2. For Windows PCs, run the Configuration Wizard to verify that the Digital Entertainer Elite and the computer can communicate. From the Windows Start menu, select All Programs > NETGEAR Digital Entertainer for Windows > Configuration Wizard.
3. For other systems, try rebuilding the server list. Press  **Home**, and select More > Supervisor functions > Advanced settings > Servers and shared folders > Build network shares list. If you do not see the server, check your network connections and router firewall settings, and try to ping the IP of the Digital Entertainer Elite.
4. Try accessing the server from other Windows-based PCs. If these PCs can see the server, the Digital Entertainer Elite will too.

Using Ping

To use ping:

1. From the Windows taskbar, click the Start button, and select Run.
2. In the field provided, type **ping** followed by the IP address of the Digital Entertainer Elite. Displaying the IP address is described in [“IP Address” on page 7-9](#). For example, type:

ping 192.168.0.2

3. Click **OK**. You should see a message like this one:

pinging <IP address> with 32 bytes of data

If the path is working, you see this message:

reply from < IP address >: bytes=32 time=NN ms TTL=xxx

If the path is not working, you see this message:

request timed out

If you cannot ping the Digital Entertainer Elite, then your network might not be working correctly.

Unlocking the Disk Drive Tray

If you set the tray lock before installing a new disk drive, you must unlock the tray before removing the drive. Insert a push-pin or a paper clip into the center of the release button to unlock the latch and open the tray (see below).

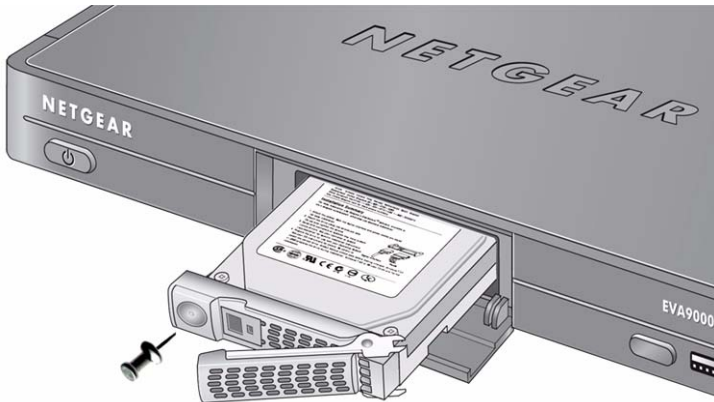

Figure 7-2

Appendix A

Default Configuration and Technical Specifications

This appendix describes the factory default settings, supported media file formats, and technical specifications for the Digital Entertainer Elite.

Default Settings

The following table lists the default settings of your Digital Entertainer Elite.

Table A-1. Default Configuration Settings

Feature	Description
Media Player	
Language	English
Video mode	Standard definition NTSC
Room name	Computer room
Network connection	Wired LAN
Wireless	
Wireless Communication	Disabled
Wireless Network Name (SSID)	Any
Security	Disabled
Network Type	Infrastructure
Transmission Speed	Auto ^a
Country/Region	United States (varies by region)
Operating Mode	n, g and b
Data Rate	

- a. Maximum wireless signal rate derived from IEEE Standard 802.11 specifications. Actual throughput will vary. Network conditions and environmental factors, including volume of network traffic, building materials and construction, and network overhead, lower actual data throughput rate.

Supported Media File Formats

A number of file formats are supported for live streaming. Formats are added regularly. To see the most current list, go to

<http://kbserver.netgear.com/products/eva.asp> and select the EVA9000 or the EVA9150; then access the Media formats link for file formats supported by your model.

Technical Specifications

Table A-2. Technical Specifications

Feature	Description
Data and routing protocols	TCP/IP, DHCP
Power adapter	<ul style="list-style-type: none"> • North America: 120V, 60 Hz, input • United Kingdom, Australia: 240V, 50 Hz, input • Europe: 230V, 50 Hz, input • Japan: 100V, 50/60 Hz, input • Maximum input current NA: 0.24A; UK; AU: 0.15A; EU: 0.15A; JP: 0.27A
Physical specifications	<ul style="list-style-type: none"> • Dimensions (H x W x D): 1.5 x 17 x 10 in. (38.1 x 431.8 x 254 mm) • Weight: 4.4 lbs (2.0 kg)
Environmental specifications	<ul style="list-style-type: none"> • Operating temperature: 32°–104° F (0°–40° C) • Operating humidity: 90% maximum relative humidity, noncondensing
Electromagnetic emissions	FCC Part 15 Class B, VCCI Class B, EN 55 022 (CISPR 22), Class B C-Tick N10947
Interface	LAN: 10BASE-T or 100BASE-Tx, RJ-45 WLAN: 802.11/b/g/n
Radio data rates	11a, 11b, 11g & 11n data rates (Auto Rate Sensing)
Frequency	2400 - 2483.5 MHz 5150 - 5825MHz
Data encoding	Standards <ul style="list-style-type: none"> • IEEE 802.11n draft • IEEE 802.11b, IEEE 802.11g, IEEE 802.11n - 2.4 GHz • IEEE 802.11a, IEEE 802.11n - 5.0 GHz
Operating frequency ranges	<ul style="list-style-type: none"> • US 2.4Ghz 2400 Mhz-2462 Mhz • EU 2.4Ghz 2400 Mhz-2483.5 Mhz • US 5 Ghz non-DFS 5150 Mhz-5250 Mhz and 5725 Mhz-5875 Mhz • EU 5 Ghz 5150-5250, 5250-5350, 5475-5725, 5725-5875
802.11 security	40-bit (also called 64-bit) and 128-bit WEP, WPA-PSK, and WPA2-PSK

Appendix B

Related Documents

This appendix provides links to reference documents you can use to gain a more complete understanding of the technologies used in your NETGEAR product.

Document	Link
Windows XP and Vista Wireless Configuration Utilities	http://documentation.netgear.com/reference/enu/winzerocfg/index.htm
Internet Networking and TCP/IP Addressing	http://documentation.netgear.com/reference/enu/tcpip/index.htm
Wireless Communications	http://documentation.netgear.com/reference/enu/wireless/index.htm
Preparing a Computer for Network Access	http://documentation.netgear.com/reference/enu/wsdhcp/index.htm
Virtual Private Networking (VPN)	http://documentation.netgear.com/reference/enu/vpn/index.htm
Glossary	http://documentation.netgear.com/reference/enu/glossary/index.htm

A

- accessing
 - enabling for media library [2-5, 2-6](#)
 - Internet Channels [4-17](#)
 - media [7-3](#)
 - network security [5-11](#)
- adding
 - album art [5-3, 5-4](#)
 - cover art [5-2, 5-3](#)
 - video frames for cover art [5-2](#)
- art
 - adding album art [5-3, 5-4](#)
 - adding cover art [5-2, 5-3](#)
 - adding video frames for cover art [5-2](#)

B

- basic setup [2-3](#)
- browser
 - interface [3-4](#)
 - navigating [3-3](#)

C

- Configuration [3-7](#)
- Configuration Wizard feature [1-2, 2-6, 7-2, 7-6, 7-10](#)
- connecting
 - Digital Entertainer [2-1](#)
 - network connections [7-7](#)
 - server [7-9](#)

D

- default settings
 - resetting to [7-1](#)
 - specifications [A-1](#)

Digital [2-5](#)

- Digital Entertainer
 - box checklist [1-1](#)
 - PC Access [6-9](#)
 - using multiple [3-7, 4-18](#)

- Digital Entertainer for Windows software
 - installing [2-5](#)
 - multiple Digital Entertainers [4-18](#)
 - PC Access [6-9](#)
 - protected media [3-7, 4-3](#)
 - setup [2-1](#)
 - troubleshooting [7-7, 7-9](#)
 - with YouTube content [4-13](#)

Documentation [1-2](#)

E

- error messages [7-4](#)
- Ethernet LAN connection [7-7](#)

F

- File [6-5](#)
- File Sharing [4-12, 6-5](#)
- firewall port settings [7-2](#)
- flash drives [4-8](#)
- Follow me feature [3-7, 6-8](#)
- formats
 - supported [A-2](#)

H

- Hard Drive Tools [6-3](#)
- hot keys [3-2, 6-9](#)

I

Internet Channels [4-17](#)
IP address [7-9](#)
iPod content [1-6, 4-8, 4-9, 6-2](#)
iTunes for Windows [3-6, 3-7, 4-3, 4-9](#)

L

Linux [1-2, 2-1, 4-8, 6-1, 7-3](#)

M

Macintosh [1-2, 2-1, 2-3, 4-8, 7-3](#)
media
 accessing [7-3](#)
 combining different sources [4-18](#)
 listening [4-1](#)
 protected media [3-6, 4-3, 4-4](#)
media library
 enabling for accessing [2-5, 2-6](#)
 improving search results [5-1](#)
 management [6-7](#)
MP3 content [4-1, 5-7, 6-2](#)
multi-part video [5-4](#)

N

navigating
 browser [3-3](#)
 with remote control [3-1](#)
network security [5-11](#)

O

optimizing
 home network performance [5-7](#)
 media file performance [5-10](#)
 network bandwidth performance [5-9](#)
 remote control [3-3](#)
 speed [5-7](#)
 streaming video [5-11](#)
 wireless performance [5-7](#)
overview
 accessing media [7-3](#)

Digital Entertainer [1-2](#)
home networking [5-5](#)
remote control [3-2](#)
supervisor functions [6-2](#)
tagging [5-1](#)
USB-connected media devices [4-8](#)

P

parental control [5-1, 5-12, 5-13](#)
passwords
 Windows system [7-3](#)
PC Access feature [3-2, 6-9](#)
performance
 home network [5-7](#)
 media files [5-10](#)
 network bandwidth [5-9](#)
 optimizing speed [5-7](#)
 remote control [3-3](#)
 streaming video [5-11](#)
 wireless [5-7](#)
pinging [7-10](#)
playing
 Internet media [4-13](#)
 Internet radio [4-16](#)
 media from the browser interface [3-5](#)
 status [4-19](#)
 trouble with media [7-2](#)
Power and Hard Drive [6-5](#)
protected media [3-6, 4-3, 4-4](#)

R

remote control
 navigating [3-1](#)
 overview [3-2](#)
 playing music [4-2](#)
 tips [3-3](#)
 viewing photos [4-5](#)
 with Internet radio [4-17](#)
 with Recorded Video [4-7](#)
 with YouTube content [4-15](#)
room control [3-4, 3-7, 5-6](#)
RSS news feeds [3-3, 4-17](#)

S

- Script Wizard feature [5-4](#)
- Send message feature [3-7](#), [6-8](#)
- setting up
 - basic [2-3](#)
 - network connection [6-7](#)
 - network shares [6-7](#)
- settings
 - default [7-1](#), [A-1](#)
 - firewall port [7-2](#)
 - more about [6-8](#)
- Software updates [1-2](#)
- streaming video [5-11](#)
- supervisor functions [6-2](#)
- supported media file formats [A-2](#)
- system information [6-9](#)

T

- Tag Tool feature [1-2](#), [1-3](#), [3-3](#), [5-1](#), [5-2](#), [5-4](#)
- tagging
 - example for a multi-part video [5-4](#)
 - overview [5-1](#)
 - using the Script Wizard [5-4](#)
 - video script example [5-5](#)
- technical specifications
 - general [A-2](#)
- troubleshooting
 - playing media [7-2](#)
 - resetting to factory defaults [7-1](#)
 - tips [7-6](#)
 - wireless networks [7-7](#)

U

- USB-connected media devices [4-8](#)

V

- Video Script feature [5-5](#)
- view
 - front [1-4](#)
 - rear [1-5](#)
- viewing
 - news [4-17](#)
 - photos [4-4](#)
 - recorded video [4-6](#)
 - status [4-19](#)
 - weather [4-17](#)
 - YouTube content [4-14](#)

W

- Windows Media Digital Rights Management (DRM) [3-6](#)
- Windows Media Player 11 [3-6](#)
- Windows Media Player Version 11 [3-6](#)
- Windows Sharing and Security [2-5](#)
- wireless networks
 - range and interference [7-8](#)
 - tips [7-8](#)
 - troubleshooting [7-7](#)

Y

- YouTube content [2-4](#), [3-1](#), [4-13](#), [4-14](#), [4-15](#)

Compliance

Certificate of the Manufacturer/Importer

It is hereby certified that the Digital Entertainer Elite, EVA9000/9150 has been suppressed in accordance with the conditions set out in the BMPT-AmtsblVfg 243/1991 and Vfg 46/1992. The operation of some equipment (for example, test transmitters) in accordance with the regulations may, however, be subject to certain restrictions. Please refer to the notes in the operating instructions.

The Federal Office for Telecommunications Approvals has been notified of the placing of this equipment on the market and has been granted the right to test the series for compliance with the regulations.

Bestätigung des Herstellers/Importeurs

Es wird hiermit bestätigt, daß das Digital Entertainer Elite, EVA9000/9150 gemäß der im BMPT-AmtsblVfg 243/1991 und Vfg 46/1992 aufgeführten Bestimmungen entstört ist. Das vorschriftsmäßige Betreiben einiger Geräte (z.B. Testsender) kann jedoch gewissen Beschränkungen unterliegen. Lesen Sie dazu bitte die Anmerkungen in der Betriebsanleitung.

Das Bundesamt für Zulassungen in der Telekommunikation wurde davon unterrichtet, daß dieses Gerät auf den Markt gebracht wurde und es ist berechtigt, die Serie auf die Erfüllung der Vorschriften hin zu überprüfen.

Voluntary Control Council for Interference (VCCI) Statement

This equipment is in the Class B category (information equipment to be used in a residential area or an adjacent area thereto) and conforms to the standards set by the Voluntary Control Council for Interference by Data Processing Equipment and Electronic Office Machines aimed at preventing radio interference in such residential areas. When used near a radio or TV receiver, it may become the cause of radio interference. Read instructions for correct handling.

FCC Information to User

This product does not contain any user serviceable components and is to be used with approved antennas only. Any product changes or modifications will invalidate all applicable regulatory certifications and approvals

FCC Guidelines for Human Exposure

This equipment complies with FCC radiation exposure limits set forth for an uncontrolled environment. This equipment should be installed and operated with minimum distance of 20 cm between the radiator and your body.

This transmitter must not be co-located or operating in conjunction with any other antenna or transmitter.”

Declaration Of Conformity

We NETGEAR, Inc. 350 E. Plumeria Drive San Jose, CA 95134 USA, declare under our sole responsibility that the Digital Entertainer Elite, EVA9000/9150 complies with Part 15 of FCC Rules. Operation is subject to the following two conditions:

- This device may not cause harmful interference, and
- This device must accept any interference received, including interference that may cause undesired operation.

Regulatory Compliance Information

This section includes user requirements for operating this product in accordance with National laws for usage of radio spectrum and operation of radio devices. Failure of the end-user to comply with the applicable requirements may result in unlawful operation and adverse action against the end-user by the applicable National regulatory authority.

NOTE: This product's firmware limits operation to only the channels allowed in a particular Region or Country. Therefore, all options described in this user's guide may not be available in your version of the product.

FCC Requirements for Operation in the United States

Radio Frequency Interference Warnings and Instructions

This equipment has been tested and found to comply with the limits for a Class B digital device, pursuant to Part 15 of the FCC Rules. These limits are designed to provide reasonable protection against harmful interference in a residential installation. This equipment uses and can radiate radio frequency energy and, if not installed and used in accordance with the instructions, may cause harmful interference to radio communications. However, there is no guarantee that interference will not occur in a particular installation. If this equipment does cause harmful interference to radio or television reception, which can be determined by turning the equipment off and on, the user is encouraged to try to correct the interference by one or more of the following methods:

- Reorient or relocate the receiving antenna.
- Increase the separation between the equipment and the receiver.
- Connect the equipment into an electrical outlet on a circuit different from that which the radio receiver is connected.
- Consult the dealer or an experienced radio/TV technician for help.

Modifications made to the product, unless expressly approved by NETGEAR, Inc., could void the user's right to operate the equipment.

Export Restrictions

This product or software contains encryption code that may not be exported or transferred from the US or Canada without an approved US Department of Commerce export license.



This device is a 2.4 GHz low power RF device intended for home and office use in EU and EFTA member states. In some EU / EFTA member states some restrictions may apply. Please contact local spectrum management authorities for further details before putting this device into operation.

Marking by the above symbol indicates compliance with the Essential Requirements of the R&TTE Directive of the European Union (1999/5/EC). This equipment meets the following conformance standards: EN300 328, EN301 489-17, EN60950.

Requirements For Operation in the European Community

Countries of Operation and Conditions of Use in the European Community

The user should run the client utility program provided with this product to check the current channel of operation and confirm that the device is operating in conformance with the spectrum usage rules for European Community countries as described in this section.

This device is intended to be operated in all countries of the European Community.

Operation Using 2.4 GHz Channels in France

The following radio channel usage limitations apply in France.

The radio spectrum regulator in France, Autorité de regulation des telecommunications (ART), enforces the following rules with respect to use of 2.4 GHz spectrum in various locations in France. Please check ART's web site for latest requirements for use of the 2.4 GHz band in France: <http://www.art-telecom.fr/eng/index.htm>. When operating in the following metropolitan regions (départements) in France, this device may be operated under the following conditions:

- Indoors using any channel in the 2.4-2.4835 GHz band (Channels 1-13)
- Outdoors using channels in the 2.4-2.454 GHz band (Channels 1-7)

When operating outside of the following regions (départements) in France (see table below), this product must be operated under the following conditions:

- Indoors using channels in the 2.4465-2.4835 GHz band (Channels 10-13).
- Outdoor operation not permitted.

Refer to the ART website for further details.

European Union Statement of Compliance

Hereby, NETGEAR, Inc. declares that this digital media player is in compliance with the essential requirements and other relevant provisions of Directive 1999/5/EC.

Ěesky [Czech]	NETGEAR, Inc. tímto prohlašuje, že tento Digital Entertainer Elite, EVA9000/9150 je ve shodě se základními požadavky a dalšími příslušnými ustanoveními směrnice 1999/5/ES.
Dansk [Danish]	Undertegnede NETGEAR, Inc. erklærer herved, at følgende udstyr Digital Entertainer Elite, EVA9000/9150 overholder de væsentlige krav og øvrige relevante krav i direktiv 1999/5/EF.
Deutsch [German]	Hiermit erklärt NETGEAR, Inc., dass sich das Gerät Digital Entertainer Elite, EVA9000/9150 in Übereinstimmung mit den grundlegenden Anforderungen und den übrigen einschlägigen Bestimmungen der Richtlinie 1999/5/EG befindet.
Eesti [Estonian]	Käesolevaga kinnitab NETGEAR, Inc. seadme Digital Entertainer Elite, EVA9000/9150 vastavust direktiivi 1999/5/EÜ põhinõuetele ja nimetatud direktiivist tulenevatele teistele asjakohastele sätetele.
English	Hereby, NETGEAR, Inc., declares that this Digital Entertainer Elite, EVA9000/9150 is in compliance with the essential requirements and other relevant provisions of Directive 1999/5/EC.
Español [Spanish]	Por medio de la presente NETGEAR, Inc. declara que el Digital Entertainer Elite, EVA9000/9150 cumple con los requisitos esenciales y cualesquiera otras disposiciones aplicables o exigibles de la Directiva 1999/5/CE.
Ελληνική [Greek]	ΜΕ ΤΗΝ ΠΑΡΟΥΣΑ NETGEAR, Inc. ΔΗΛΩΝΕΙ ΟΤΙ Digital Entertainer Elite, EVA9000/9150 ΣΥΜΜΟΡΦΩΝΕΤΑΙ ΠΡΟΣ ΤΙΣ ΟΥΣΙΩΔΕΙΣ ΑΠΑΙΤΗΣΕΙΣ ΚΑΙ ΤΙΣ ΛΟΙΠΕΣ ΣΧΕΤΙΚΕΣ ΔΙΑΤΑΞΕΙΣ ΤΗΣ ΟΔΗΓΙΑΣ 1999/5/ΕΚ.

Français [French]	Par la présente NETGEAR, Inc. déclare que l'appareil Digital Entertainer Elite, EVA9000/9150 est conforme aux exigences essentielles et aux autres dispositions pertinentes de la directive 1999/5/CE.
Italiano [Italian]	Con la presente NETGEAR, Inc. dichiara che questo Digital Entertainer Elite, EVA9000/9150 è conforme ai requisiti essenziali ed alle altre disposizioni pertinenti stabilite dalla direttiva 1999/5/CE.
Latviski [Latvian]	Ar šo NETGEAR, Inc. deklarā, ka Digital Entertainer Elite, EVA9000/9150 atbilst Direktīvas 1999/5/EK būtiskajām prasībām un citiem ar to saistītajiem noteikumiem.
Lietuvių [Lithuanian]	Šiuo NETGEAR, Inc. deklaruoja, kad šis Digital Entertainer Elite, EVA9000/9150 atitinka esminius reikalavimus ir kitas 1999/5/EB Direktyvos nuostatas.
Nederlands [Dutch]	Hierbij verklaart NETGEAR, Inc. dat het toestel Digital Entertainer Elite, EVA9000/9150 in overeenstemming is met de essentiële eisen en de andere relevante bepalingen van richtlijn 1999/5/EG.
Malti [Maltese]	Hawnhekk, NETGEAR, Inc., jiddikjara li dan Digital Entertainer Elite, EVA9000/9150 jikkonforma mal-tiġiet essenzjali u ma provvedimenti orajn relevanti li hemm fid-Dirrettiva 1999/5/EC.
Magyar [Hungarian]	Alulírott, NETGEAR, Inc. nyilatkozom, hogy a Digital Entertainer Elite, EVA9000/9150 megfelel a vonatkozó alapvető követelményeknek és az 1999/5/EC irányelv egyéb előírásainak.
Polski [Polish]	Niniejszym NETGEAR, Inc. oświadczam, że Digital Entertainer Elite, EVA9000/9150 jest zgodny z zasadniczymi wymogami oraz pozostałymi stosownymi postanowieniami Dyrektywy 1999/5/EC.
Português [Portuguese]	NETGEAR, Inc. declara que este Digital Entertainer Elite, EVA9000/9150 está conforme com os requisitos essenciais e outras disposições da Directiva 1999/5/CE.
Slovensko [Slovenian]	NETGEAR, Inc. izjavlja, da je ta Digital Entertainer Elite, EVA9000/9150 v skladu z bistvenimi zahtevami in ostalimi relevantnimi določili direktive 1999/5/ES.
Slovensky [Slovak]	NETGEAR, Inc. týmto vyhlasuje, že Digital Entertainer Elite, EVA9000/9150 spáda základné požiadavky a všetky príslušné ustanovenia Smernice 1999/5/ES.
Suomi [Finnish]	NETGEAR, Inc. vakuuttaa täten että Digital Entertainer Elite, EVA9000/9150 tyyppinen laite on direktiivin 1999/5/EY oleellisten vaatimusten ja sitä koskevien direktiivin muiden ehtojen mukainen.
Svenska [Swedish]	Härmed intygar NETGEAR, Inc. att denna Digital Entertainer Elite, EVA9000/9150 står i överensstämmelse med de väsentliga egenskapskrav och övriga relevanta bestämmelser som framgår av direktiv 1999/5/EG.

A printed copy of the EU Declaration of Conformity certificate for this product is provided in the EVA9000 product package.

Canadian Department of Communications Radio Interference Regulations

This digital apparatus (Digital Entertainer Elite, EVA9000/9150) does not exceed the Class B limits for radio-noise emissions from digital apparatus as set out in the Radio Interference Regulations of the Canadian Department of Communications.

Industry Canada Statement

This device complies with RSS-210 of the Industry Canada Rules. Operation is subject to the following two conditions: (1) This device may not cause harmful interference, and (2) this device must accept any interference received, including interference that may cause undesired operation.

Macrovision Notice:

This product incorporates copyright protection technology that is protected by U.S. patents and other intellectual property rights. Use of this copyright protection technology must be authorized by Macrovision, and is intended for home and other limited viewing uses only unless otherwise authorized by Macrovision. Reverse engineering or disassembly is prohibited.

IMPORTANT NOTE

Radiation Exposure Statement

This equipment complies with IC radiation exposure limits set forth for an uncontrolled environment. End users must follow the specific operating instructions for satisfying RF exposure compliance. To maintain compliance with IC RF exposure compliance requirements, please follow operation instruction as documented in this manual.

The Class [B] digital apparatus meets all requirements of the Canadian Interference-Causing Equipment Regulation.

Cet appareil numérique de la class [B] respecte toutes les exigences du Règlement sur le matériel brouilleur du Canada.

Software License Agreement

1. This Software License Agreement (the "Agreement") is a legal agreement between you (either an individual or an entity) ("You") and NETGEAR, Inc. ("NETGEAR") regarding the use of NETGEAR's software provided with the Digital Entertainer Elite, EVA9000/9150 (inside the Digital Entertainer Elite, EVA9000/9150, any accompanying CDs, and any accompanying documentation; together, the "Software"). BEFORE YOU USE THIS SOFTWARE, CAREFULLY READ THE TERMS AND CONDITIONS OF THIS AGREEMENT. IF YOU ARE NOT AUTHORIZED TO SIGN, THEN DO NOT DOWNLOAD, INSTALL OR USE THE SOFTWARE, BECAUSE BY DOING SO, YOU ARE AGREEING TO BE BOUND BY THIS AGREEMENT. IF YOU DO NOT AGREE TO ALL OF THE TERMS OF THIS AGREEMENT, DO NOT DOWNLOAD, INSTALL OR USE THIS SOFTWARE, AND DESTROY OR RETURN ALL COPIES IN YOUR POSSESSION.
2. Subject to the restrictions set forth below, NETGEAR grants You a nonexclusive, personal, nontransferable, perpetual (subject to Section 5) license to install and use 1 copy of the provided version of the Software in object code format, for internal and personal purposes only, on 1 computer. The Software is "in use" on a computer when it is loaded into the temporary memory or installed into the permanent memory of a computer. The license granted hereunder shall not be effective until You have paid all fees in full. Except for the license rights granted above, NETGEAR and NETGEAR's licensors retain all right, title and interest in and to the Software, including all intellectual property rights therein. YOU MAY NOT (AND MAY NOT ALLOW A THIRD PARTY TO) (a) RENT, LEASE, SUBLICENSE, SELL, ASSIGN, LOAN, USE FOR TIMESHARING OR SERVICE BUREAU PURPOSES OR OTHERWISE TRANSFER THE SOFTWARE OR ANY OF YOUR RIGHTS AND OBLIGATIONS UNDER THIS AGREEMENT; (b) reverse engineer, decompile, disassemble or attempt to reconstruct, identify or discover any source code, underlying ideas, underlying user interface techniques or algorithms of the Software by any means whatsoever, except to the extent the foregoing restrictions are expressly prohibited by applicable law; (c) remove or destroy any copyright notices or other proprietary markings; (d) attempt to circumvent any use restrictions; (e) modify or adapt the Software, merge the Software into another program or create derivative works based on the Software; (f) use, copy or distribute the Software without NETGEAR's written authorization, excepting 1 copy for archival or backup purposes only; or (g) use the Software or the Digital Entertainer Elite, EVA9000/9150 for commercial use. YOU MAY NOT (AND MAY NOT ALLOW A THIRD PARTY TO) COPY, REPRODUCE, CAPTURE, STORE, RETRANSMIT, DISTRIBUTE, OR BURN TO CD (OR ANY OTHER FORMAT) ANY

COPYRIGHTED CONTENT (INCLUDING BUT NOT LIMITED TO MUSICAL AND MUSIC-RELATED) THAT YOU ACCESS OR RECEIVE THROUGH USE OF THE SOFTWARE. YOU ASSUME ALL RISK AND LIABILITY, CIVIL AND CRIMINAL, FOR ANY SUCH PROHIBITED USE OF COPYRIGHTED CONTENT.

3. THIS AGREEMENT SHALL BE EFFECTIVE UPON INSTALLATION OF THE SOFTWARE AND SHALL TERMINATE UPON THE EARLIER OF: (A) YOUR FAILURE TO COMPLY WITH ANY TERM OF THIS AGREEMENT OR (B) RETURN, DESTRUCTION OR DELETION OF ALL COPIES OF THE SOFTWARE IN YOUR POSSESSION. NETGEAR's rights and your obligations shall survive any termination of this Agreement. Upon termination of this Agreement, You shall certify in writing to NETGEAR or such NETGEAR licensor that all copies of the Software have been destroyed or deleted from any of your computer libraries or storage devices.
4. NETGEAR warrants that the Software will perform substantially in accordance with the documentation accompanying the Software for a period of 90 days after your initial receipt of the Software. NETGEAR's entire liability and your exclusive remedy for breach of this warranty shall be repair or replacement of the Software. This limited warranty shall be void if failure of the Software has resulted from any accident, abuse, misuse or misapplication by You. EXCEPT AS SET FORTH ABOVE, THE SOFTWARE IS PROVIDED ON AN "AS IS" BASIS. YOU ASSUME ALL RESPONSIBILITY FOR SELECTION OF THE SOFTWARE TO ACHIEVE YOUR INTENDED RESULTS AND FOR THE INSTALLATION OF, USE OF AND RESULTS OBTAINED FROM THE SOFTWARE. TO THE MAXIMUM EXTENT PERMITTED BY APPLICABLE LAW, NETGEAR DISCLAIMS ALL WARRANTIES, EITHER EXPRESS, IMPLIED OR STATUTORY, INCLUDING, BUT NOT LIMITED TO, IMPLIED WARRANTIES OF MERCHANTABILITY, NONINFRINGEMENT, QUALITY, ACCURACY, FITNESS FOR A PARTICULAR PURPOSE, AND FITNESS FOR YOUR PURPOSE WITH RESPECT TO THE SOFTWARE AND THE ACCOMPANYING WRITTEN MATERIALS. THERE IS NO WARRANTY AGAINST INTERFERENCE WITH THE ENJOYMENT OF THE SOFTWARE OR AGAINST INFRINGEMENT. NETGEAR DOES NOT WARRANT THAT THE FUNCTIONS CONTAINED IN THE SOFTWARE WILL MEET YOUR REQUIREMENTS, BE UNINTERRUPTED OR ERROR-FREE, OR THAT ALL DEFECTS IN THE SOFTWARE WILL OR CAN BE CORRECTED.
5. In the event that a claim alleging infringement or misappropriation of an intellectual property right arises concerning the Software, NETGEAR in its sole discretion may elect to defend or settle such claim. NETGEAR, in the event of such claim, may also in its sole discretion, elect to terminate this Agreement and all rights to use the Software and require the return and/or destruction of the Software, with a refund of the fees paid for use of the Software less a reasonable allowance for use and shipping. THE FOREGOING ARE NETGEAR'S SOLE EXCLUSIVE OBLIGATIONS, AND YOUR SOLE AND EXCLUSIVE REMEDIES, WITH RESPECT TO INFRINGEMENT AND/OR MISAPPROPRIATION OF ANY INTELLECTUAL PROPERTY RIGHT.
6. UNDER NO CIRCUMSTANCES WILL NETGEAR OR ITS LICENSORS BE LIABLE FOR ANY CONSEQUENTIAL, SPECIAL, INDIRECT, INCIDENTAL OR PUNITIVE DAMAGES WHATSOEVER (INCLUDING, WITHOUT LIMITATION, DAMAGES FOR LOSS OF PROFITS, INTERRUPTION, LOSS OF BUSINESS INFORMATION, LOSS OF DATA OR OTHER SUCH PECUNIARY LOSS), WHETHER BASED ON BREACH OF CONTRACT, TORT (INCLUDING NEGLIGENCE), STRICT LIABILITY, PRODUCT LIABILITY OR OTHERWISE, ARISING OUT OF THE USE OR INABILITY TO USE THE SOFTWARE, EVEN IF NETGEAR AND/OR ITS LICENSORS HAVE BEEN ADVISED OF THE POSSIBILITY OF SUCH DAMAGES. IN NO EVENT SHALL NETGEAR'S AND ITS LICENSORS' AGGREGATE LIABILITY FOR DAMAGES ARISING OUT OF THIS AGREEMENT EXCEED THE FEES PAID BY YOU FOR THE SOFTWARE. THE FOREGOING LIMITATIONS ARE INDEPENDENT OF THE EXCLUSIVE REMEDY PROVIDED IN SECTION 5 ABOVE AND SHALL APPLY NOTWITHSTANDING ANY FAILURE OF SUCH EXCLUSIVE REMEDY OR OF ITS ESSENTIAL PURPOSE. THE FOREGOING EXCLUSIONS AND LIMITATIONS OF LIABILITY AND DAMAGES SHALL NOT APPLY TO CONSEQUENTIAL DAMAGES FOR PERSONAL INJURY.
7. You may not export or re-export the Software without: (a) the prior written consent of NETGEAR, (b) complying with applicable export control laws, including, but not limited to, restrictions and regulations of the Department of Commerce or other United States agency or authority, and (c) obtaining any necessary permits and licenses. In any event, You may not transfer or authorize the transfer of the Software to a prohibited territory or country or otherwise in violation of any applicable restrictions or regulations.
8. The Software and documentation are considered "commercial computer software" and "commercial computer software documentation," respectively, pursuant to DFAR Section 227.7202 and FAR Section 12.212, as applicable. Use, duplication or disclosure of the Software and documentation by the U.S. Government is subject to the restrictions set forth in DFAR Section 227.7202 for military agencies and FAR Section 12.212 for civilian agencies. THIS AGREEMENT IS GOVERNED BY THE LAWS OF THE STATE OF CALIFORNIA, U.S.A., WITHOUT REFERENCE TO ITS CONFLICT OF LAWS PRINCIPLES. THIS AGREEMENT WILL NOT BE GOVERNED BY THE U.N. CONVENTION ON CONTRACTS FOR THE INTERNATIONAL SALES OF GOODS. ANY DISPUTE BETWEEN YOU AND NETGEAR ARISING UNDER THIS AGREEMENT SHALL BE SUBJECT TO THE EXCLUSIVE JURISDICTION OF THE COURTS OF THE STATE OF CALIFORNIA. This Agreement is the entire agreement between You and NETGEAR regarding the subject matter herein and supersedes any other communications with respect to the Software. If any provision of this Agreement is held invalid or unenforceable, the remainder of this Agreement will continue in full force and effect. Failure to prosecute a party's rights with respect to a default hereunder will not constitute a waiver of the right to enforce rights with respect to the same or any other breach.
9. Should you have any questions relating to this Agreement, or if you desire to contact NETGEAR for any reason, please call 1-888-NETGEAR.